

BAST-421C-BW2

Wireless BACnet Communicating Thermostat for Modulating Fan Coil Operation

BASstat

Wireless Modulating Thermostat User Manual



#UM-15093500-AA1

CONTEMPORARY **CONTROLS**[®]

Trademarks

BASautomation, Contemporary Controls, and CTRLink are registered trademarks of Contemporary Control Systems, Inc. BACnet is a registered trademark of the American Society of Heating, Refrigerating and Air-Conditioning Engineers, Inc. Powered by Sedona Framework is a trademark of Tridium, Inc. Other product names may be trademarks or registered trademarks of their respective companies.

Copyright

© Copyright 2021, by Contemporary Control Systems, Inc. All rights reserved. No part of this publication may be reproduced, transmitted, transcribed, stored in a retrieval system, or translated into any language or computer language, in any form or by any means, electronic, mechanical, magnetic, optical, chemical, manual, or otherwise, without the prior written permission of:

Contemporary Control Systems, Inc.	Tel:	+1-630-963-7070
2431 Curtiss Street	Fax:	+1-630-963-0109
Downers Grove, Illinois 60515 USA	E-mail:	info@ccontrols.com

Disclaimer

Contemporary Control Systems, Inc. reserves the right to make changes in the specifications of the product described within this manual at any time without notice and without obligation of Contemporary Control Systems, Inc. to notify any person of such revision or change.

Contents

- 1 Introduction 3
 - 1.1 Features and Benefits..... 4
 - 1.2 Product Image and Main Features..... 5
- 2 Specifications 6
 - 2.1 Inputs..... 6
 - 2.2 Outputs 6
 - 2.3 Communication..... 6
 - 2.4 Electrical 6
 - 2.5 Environmental..... 7
 - 2.6 Electromagnetic Compatibility 7
 - 2.7 Mechanical (all dimensions are in mm)..... 8
- 3 Installation 9
 - 3.1 Terminal Block Pin Assignments 9
 - 3.2 Limited Power Source..... 9
 - 3.3 Power Supply Precautions..... 10
 - 3.4 Wiring Diagram 10
- 4 Operation..... 11
 - 4.1 User Mode 11
 - 4.2 Control Type 13
 - 4.3 Engineering Mode Menu..... 16
 - 4.4 BACnet Objects and Network Configuration 23
- 5 Warranty 36
- 6 Returning Products for Repair 36
- 7 Declaration of Conformity 37

1 Introduction

The BAST-421C-BW2 is a member of the BASstat BACnet Communicating Thermostat series. It provides modulated heating and cooling control in an attractive wall-mounted enclosure with a large LCD display. Intended for use with 4-pipe heated/chilled water fan coil units (FCUs), the thermostat can control 2 analog modulating water valve actuators and one binary supply fan. This BASstat is BACnet compliant to ensure seamless integration using BACnet/IP over Wi-Fi and can be integrated into any 802.11 b/g/n Wi-Fi network. A large, easy to read LCD display indicates setpoint, space temperature and current mode of operation using graphical icons.

The BASstat has a built-in space temperature sensor with provision for remote wired 3k Ω NTC thermistor sensor or temperature value can be sent by another communicating device over the BACnet network. The BASstat is configurable locally using the *Engineering Menu* or via a network connection to a BACnet client. Contemporary Controls' free [BACnet Discovery Tool](#) can be used for initial configuration of the thermostat over BACnet. Control algorithm parameters such as deadband, proportional gain, integral rate and trip points are all configurable. This BASstat also features configurable fan control and occupancy selection. Operating states are indicated on the thermostat display.

The numerous features available in the BASstat can be configured by the systems integrator to meet user requirements in two different ways. One way is using a button sequence on the thermostat in order to enter the *Engineering Menu* - which requires physical access to the thermostat. Optionally, the buttons could be locked to limit user access to *Engineering Menu* after installation is complete. The second method is configuring the thermostat over the BACnet network using a BACnet client device or software such as Contemporary Controls' free [BACnet Discovery Tool \(BDT\)](#).

NOTE: 2-pipe HVAC systems and floating-type control valve actuators are not supported by this device.

1.1 Features and Benefits

- Stand-alone thermostat algorithm or fully BACnet network-controllable
- B-ASC device profile for integration into BACnet networks
- 24VAC (+/-10%) power input
- BACnet communication -BACnet/IP over Wi-Fi and can be integrated into any 802.11 b/g/n Wi-Fi network
- Suitable for 4-pipe modulating heat/cool control applications with manual or automatic changeover **NOTE: 2-pipe heat/cool applications and floating-type valve actuator are not supported by this device**
- Adjustable algorithm applied to modulating valve control
- Effective run time accumulation for energy consumption metering
- Configurable control parameters such as deadband, proportional gain, integral rate and cycle time
- Adjustable minimum/maximum set point ranges
- Three options for temperature reading:
 - Built-in temperature sensor, or
 - Remote sensor (RS) input for wiring in a remote temperature sensor (NTC 3kΩ), or
 - BACnet network temperature override
- Occupancy status can be switched (1) locally by the user, (2) by using a separate occupancy sensor, or (3) by using BACnet network command
- Separate adjustable occupied and unoccupied set points for heating and cooling mode
- Fan can be set to run continuously or automatically
- Non-volatile memory retains user settings during power outage
- Thermostat buttons are lockable to prevent tampering
- °C or °F display
- Energy Savings Input for local occupancy control
- Control outputs disabled during “OFF” state for safety

1.2 Product Image and Main Features

BASstat 421C-B2 and BASstat 421C-BW2

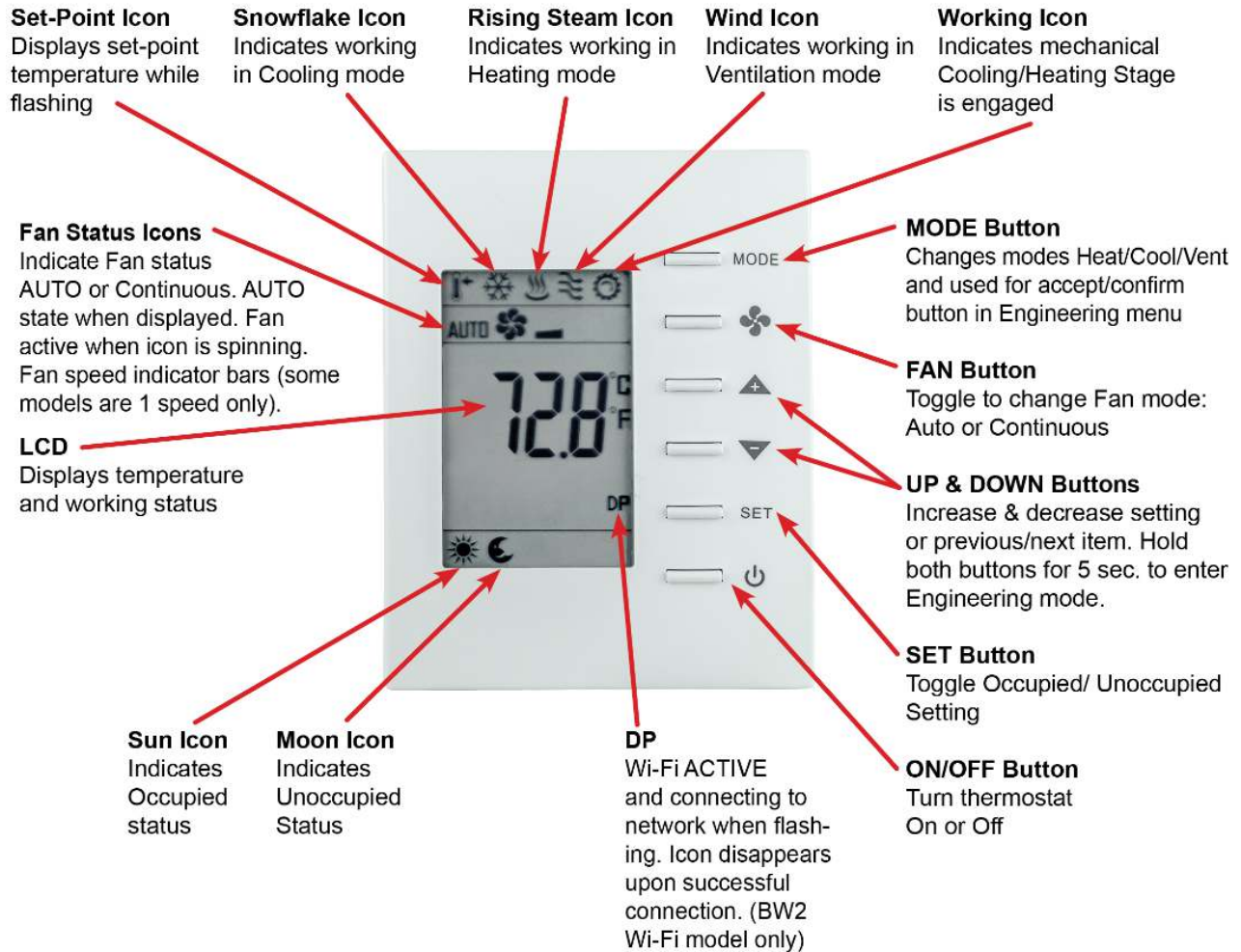

2 Specifications

2.1 Inputs

Item	Description
Temperature Display Range	-22 to 248°F (-30 to 120.0°C) with suitable sensor
Temperature Display Resolution	0.1°F (0.1°C)
Temperature Accuracy	±1.8°F (±1.0°C) with all outputs off
Energy Savings Input	Provision for external occupancy sensor
Setpoint Range	32-122°F (0-50°C) in 0.5° (°F or °C) increments
Remote Temperature Sensor	Provision for NTC Type 3kΩ thermistor

2.2 Outputs

Item	Description
Relay Output	Fan
Analog Outputs	0-10v modulating AO1 (cooling), AO2 (heating)
Contact Rating	SPST 2A at 30 VAC with inductive load
Minimum contact life	100,000 cycles

2.3 Communication

Item	Description
Protocol Compliance	BACnet/IP with B-ASC
Physical Layer	802.11 b/g/n Wi-Fi network
Cabling	None

2.4 Electrical

Item	Description
Supply Voltage and Current	24 VAC (±10%) 5 VA
Power Source Class	NFPA 70 (NEC) Article 725 Part III Class 2
Internal Power Supply	Half-wave rectified and filtered DC

2.5 Environmental

Item	Description
Operating Temperature	32° to 122°F (0 to 50°C)
Storage Temperature	14° to 140°F (-10 to +60°C)
Relative Humidity	5 to 95% non-condensing

2.6 Electromagnetic Compatibility

The BAST-421C-BW2 complies with the following specifications and bears the CE mark in accordance with the provisions of the Electromagnetic Compatibility (EMC) Directive 2004/108/EC based on the following specifications:

Standard	Test Method	Description
EN 61000-6-2	IEC 61000-4-2	Electrostatic Discharge Immunity
EN 61000-6-2	IEC 61000-4-3	Radiated, Radio-Frequency, Electromagnetic Field Immunity
EN 61000-6-2	IEC 61000-4-4	Electrical Fast Transit/Burst Immunity
EN 61000-6-2	IEC 61000-4-5	Voltage Surge Immunity
EN 61000-6-2	IEC 61000-4-6	Immunity to Conducted Disturbances
EN 61000-6-2	IEC 61000-4-8	Power Frequency Magnetic Field Immunity
EN 61000-6-2	IEC 61000-4-11	Voltage Dips and Interruptions
EN 61000-6-3	IEC 61000-3-2	Limits for Harmonic Current Emissions
EN 61000-6-3	IEC 61000-3-3	Limitation of Voltage Fluctuations and Flicker in Low Voltage Supply Systems

2.7 Mechanical (all dimensions are in mm)

Mounts directly onto wall, panel, standard 65×65mm junction box (hole pitch 60 mm) or standard 2×4-inch vertical junction box (hole pitch 83.5mm).

Width: 94mm Height: 118mm Depth: 34mm

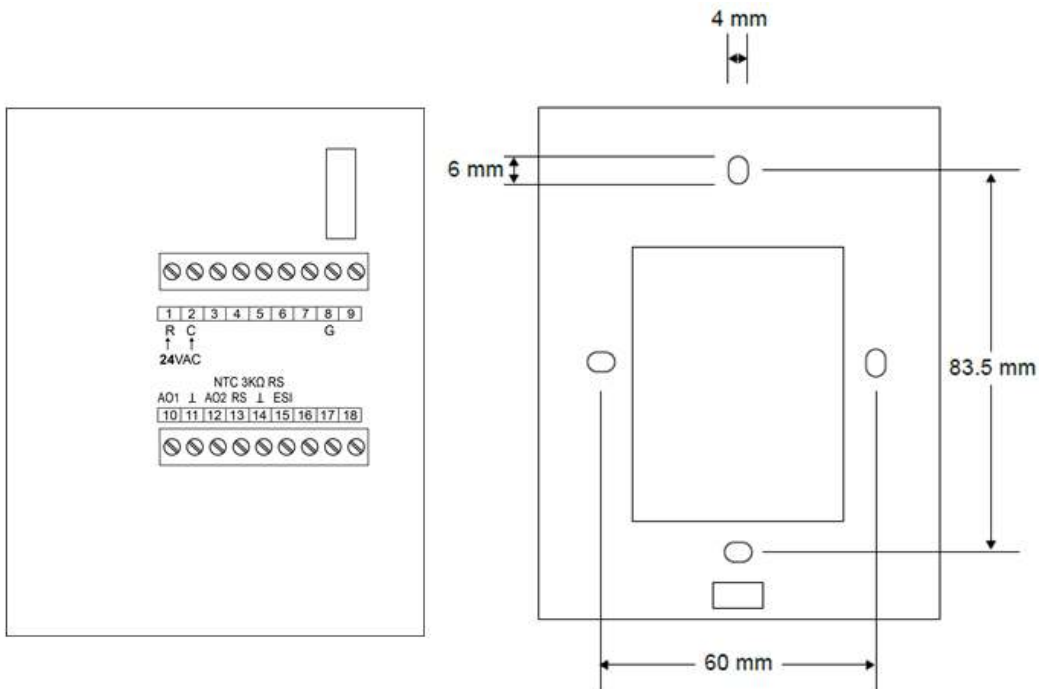
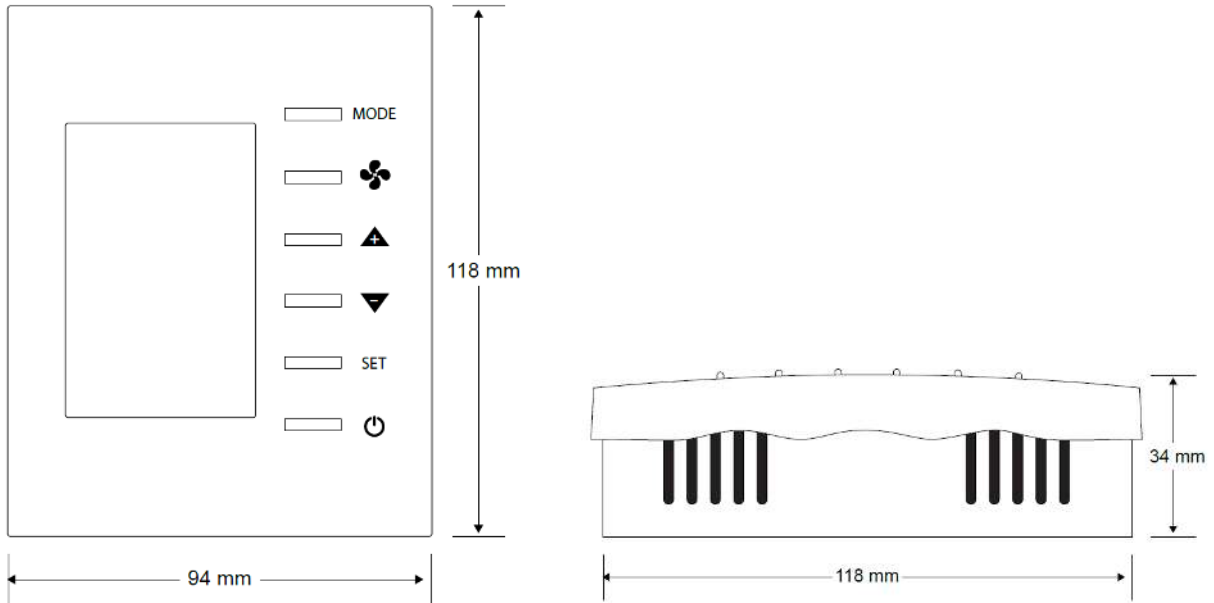

3 Installation

The BASstat 421C-BW2 is intended for surface-mount installation on an interior wall, away from direct sunlight or direct air movement. The display (top half) can be removed from its base by loosening the small Philips screw at the bottom of the display. Once the display is removed from the base, the base can be mounted onto the wall with appropriate fasteners. If a single-gang electrical junction box is to be used, the top and bottom mounting holes will align with the screw holes in the junction box.

3.1 Terminal Block Pin Assignments

Two terminal blocks are provided for all field connections. The remote sensor input (RS) is at terminals 13 and 14. The remote occupancy (ESI) input is a dry contact closure input located at terminals 14 and 15.

Number	Mark	Comment	Number	Mark	Comment
1	R	24 VAC high-side	10	AO1	Cooling Device
2	C	24 VAC common	11	COM	
3			12	AO2	Heating Device
4			13	RS	Remote Sensor Input
5			14	COM	Sensor Common
6			15	ESI	Energy Saving Input
7			16		
8	G	Fan	17		
9			18		

3.2 Limited Power Source

The BASstat is intended to be powered by a Class 2 compliant power source and only accepts 24VAC with no more than 5VA of power consumption. It should be powered by a Class 2 power source complying with the requirements of the National Electric Code (NEC) article 725. The transformer or power supply complying with the Class 2 rating must carry a corresponding listing from a regulatory agency such as Underwriters Laboratories (UL).

3.3 Power Supply Precautions

Internally, the BASstat utilizes a half-wave rectifier and can share the same AC power source with other half-wave rectified devices. Sharing AC power with full-wave rectified devices is NOT recommended. AC power sources that power several half-wave devices have a common secondary connection called COMMON, LO, or GROUND. Connect the HOT side of the secondary to the 24 VAC high side input on the BASstat and the LO side to 24 VAC common.

WARNING: Devices powered from a common AC source could be damaged if a mix of half-wave and full-wave rectified devices are both present. If you are not sure of the type of rectifier used by another device, do not share the AC source with it.

3.4 Wiring Diagram

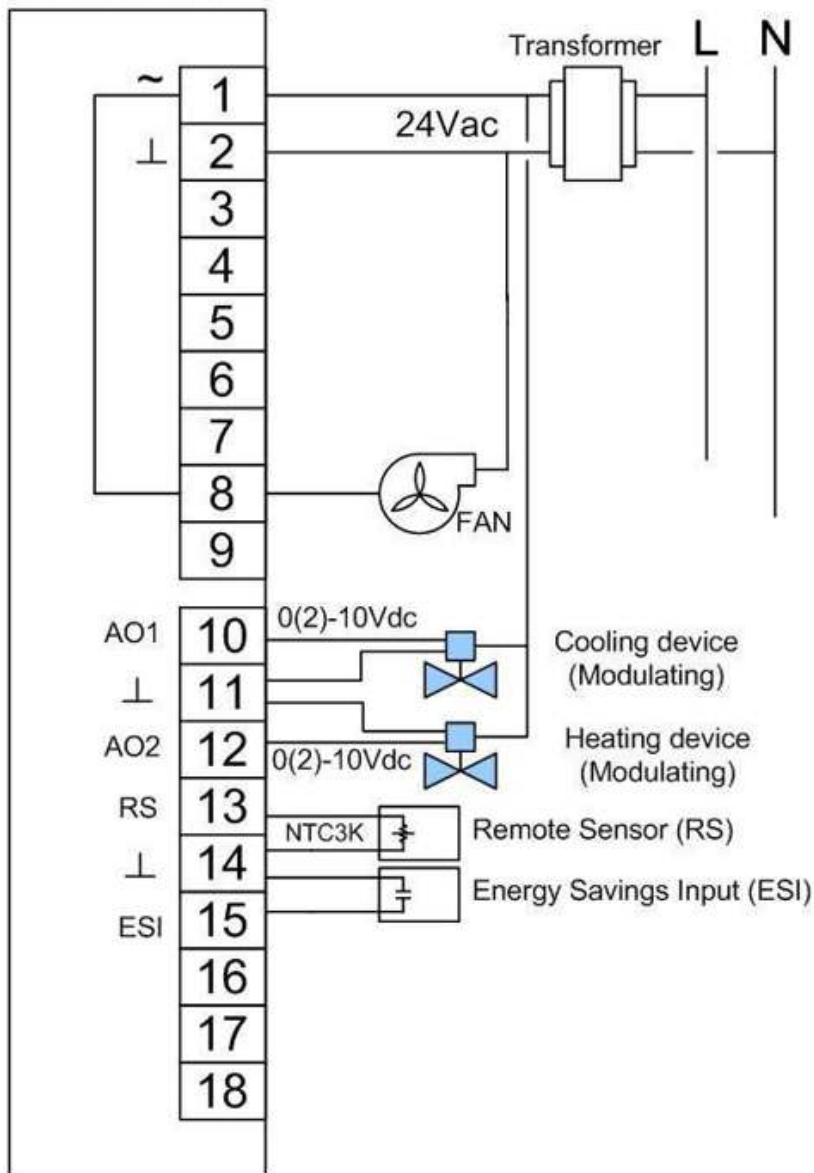

Wiring: 14 to 22 AWG wires or 1.5mm² wires.

4 Operation



4.1 User Mode



User-side control is accomplished with six buttons – MODE (Heat, Cool, or Ventilate), FAN (Auto or On), UP, DOWN, SET, and POWER. There are also options to lock the panel buttons to limit user access if so required. A large LCD display indicates setpoint, space temperature, occupancy status, and current mode of operation using graphical icons.



System modes (Cool, Heat, Ventilate) available to the user are dependent on control type chosen from *Engineering Menu (tyPE)* or BACnet object [MSV7] *Control Type*. See section 4.2 *Control Type* of this manual).

System modes and button operation may be limited by installation engineer, especially if the thermostat is completely controlled over BACnet network.

The first tier of operation includes the following settings as shown below. To operate the thermostat:





1. The POWER button  toggles between ON or OFF states to start / stop the thermostat. This will disable control (ON/OFF control can be accomplished over BACnet as well).
2. At power ON, press any button to start the User Mode operation. Press the MODE button  to toggle between different HVAC operating modes such as Cool, Heat, or Ventilate@Cool and Ventilate@Heat.

Press the UP/ DOWN buttons   to adjust temperature setpoint or rotate the values of a setting. Press the FAN button  to toggle fan modes of AUTO or CONTINUOUS On. If no AUTO icon is displayed, the fan will run continuously until commanded off using button on thermostat or BACnet command. If AUTO icon is flashing, the fan is operating under delay timer and will shut off automatically when delay timer expires.

Press the SET button  and use UP/ DOWN buttons   to toggle the unit between Occupied or Unoccupied states when outside of scheduled operation. Use SET or MODE to apply (SET button can be locked in applications forbidding occupancy state user control).

3. Thermostat will return to normal display with the last known setting if there's no button pressed for 10 seconds.

User Mode Thermostat Operation

#	Item	Description	Remarks
1	Normal Display	Display current room or set-point temperature	Use the (SP) parameter in the Engineering Menu or [MSV6] <i>Display</i> to choose Current room or Set- point temperature on display.
2	Temperature Setpoint Setting using Up/Down Arrows 	Set the desired temperature	The [AV0] / [AV3] Cool / Heat Occupied and [AV8] / [AV9] Unoccupied Cool / Heat temperature setpoints BACnet objects can be used to write or force the setpoint to a desired value from BACnet supervisor.
3	Mode Select 	Select the working mode: Cooling (❄️), Heating (🔥), or Ventilating (🌀).	After pressing the MODE button, press the UP/ DOWN button to rotate the selections. Dependent on Control Type.
4	Fan Auto/ Continuous 	Change the Fan mode between Auto or Continuous On.	When AUTO is displayed, the fan is handled automatically. When AUTO is flashing, the fan is working under a delay timer. When FAN icon is spinning but AUTO is not displayed, the fan will run continuously until commanded off.
5	Occupancy Setting 	Press SET, Used UP and DOWN arrows to toggle between the Occupied and Unoccupied setting. Use MODE or SET buttons to apply.	The SET button could be locked for applications forbidding user occupancy state control.

User Mode Flow Chart

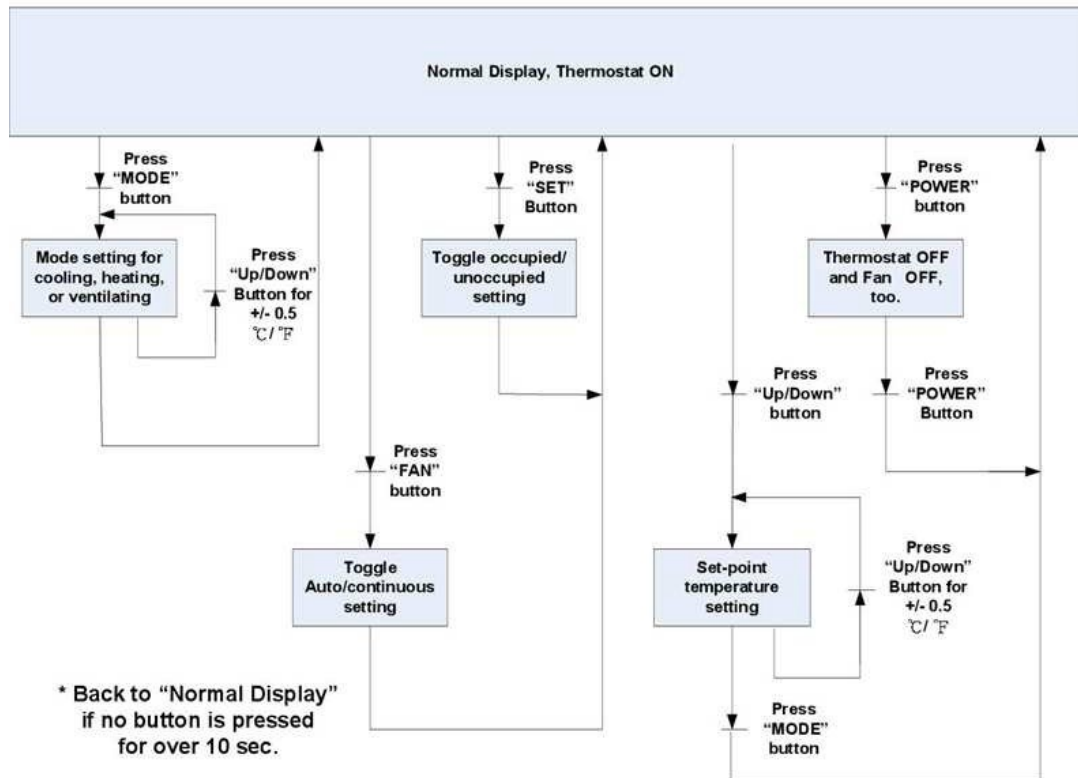

4.2 Control Type

Control Type, System Mode and Algorithm Configuration

System modes available to the user are dependent on control type.

4-Pipe Cooling or Heating with Auto Changeover – This the default control type in this thermostat. Mostly used for standalone operation. The thermostat will switch between Cool and Heat modes automatically. In this control type, the user will be presented with a choice of *Heat* or *Ventilation@Heat* when the thermostat is in *Heat* mode (automatic), and *Cool* or *Ventilation@Cool* when the thermostat is in *Cool* mode (automatic).

4-Pipe Cooling or Heating with Manual Changeover – In this control type the thermostat will wait for a command from user or BACnet supervisor to switch between Cool and Heat modes. The user will be presented with a choice of *Heat* or *Ventilation@Heat* when the thermostat is in *Heat* mode, and *Cool* or *Ventilation@Cool* when the thermostat is in *Cool* mode. The user can choose to switch between Cool and Heat modes using the MODE button.

BACnet controlled – In this control scheme, the built-in thermostat algorithm can be bypassed, and the thermostat can be controlled over the BACnet network with commands from the supervisor device. The logic executing in the supervisor (such as Niagara or Sedona logic) can control the thermostat over the BACnet network. To put the thermostat in

BACnet network control mode, use the Lock [AV18] object bit 9: Control DOs by thermostat algorithm “0” (default) or BACnet supervisor “1” (add decimal=512).

Cool Only and *Heat Only* modes (*nullified/disabled in firmware*) are control types listed in the BACnet object and Engineering Menu object but are not available for use.

Control type is only configurable by the installer using Engineering Mode Menu or BACnet supervisor. The installer must decide the control type suitable for the application, set it to a static value, or program the BACnet supervisor to change the control type automatically. The default control type is set to 4-Pipe Cooling or heating with Auto Changeover. Manual Changeover can be used to prevent excessive automatic changeover between cooling and heating system modes.

Algorithm

- A PID adaptive control algorithm is applied to minimize overshoot, in addition to proportional band (Stage Width) and derivative (Differential) calculation.
- When the thermostat is active (either the heating or cooling stage is on), a “Working ()” icon will be shown on the LCD.

System Mode

- The default control type, modulating cooling and heating with automatic changeover, allows the thermostat to operate as fully stand-alone. Manual Changeover allows restriction of mode selection to Cool only or Heat only where necessary. Control Type can be selected in (tyPe) or [MSV7].
- For manual changeover control, cooling or heating system modes can be selected by pressing the MODE button or using a BACnet command to object [MSV1]. In application where user control needs to be limited, the lock button function can be used to disable MODE button.
- Occupied Cooling [AV0] and Heating [AV3] set points and Unoccupied Cooling [AV8] and Heating [AV9] setpoints can be set individually. Minimum deadband [AV7] can be programmed as well.

Modulating Valve Offset

- The minimum control analog output voltage (low limit) for the modulating valves (AO1 and AO2) is set to 0 volts. These values can be changed at [AV11] for AO1 and [AV27] for AO2. The setting is measured as an LSB range of 0~125.

Assigned Current Temperature

- A current temperature value can be assigned thru BACnet AV-1 to take place of the onboard temperature sensor value. The assigned value is valid if BACnet communication is driving a flip-flop signal to (BV-16: heartbeat signal) within the (AV-29: Heartbeat Rate time) period (in seconds). Otherwise, the assigned temperature will revert back to the onboard sensor reading.

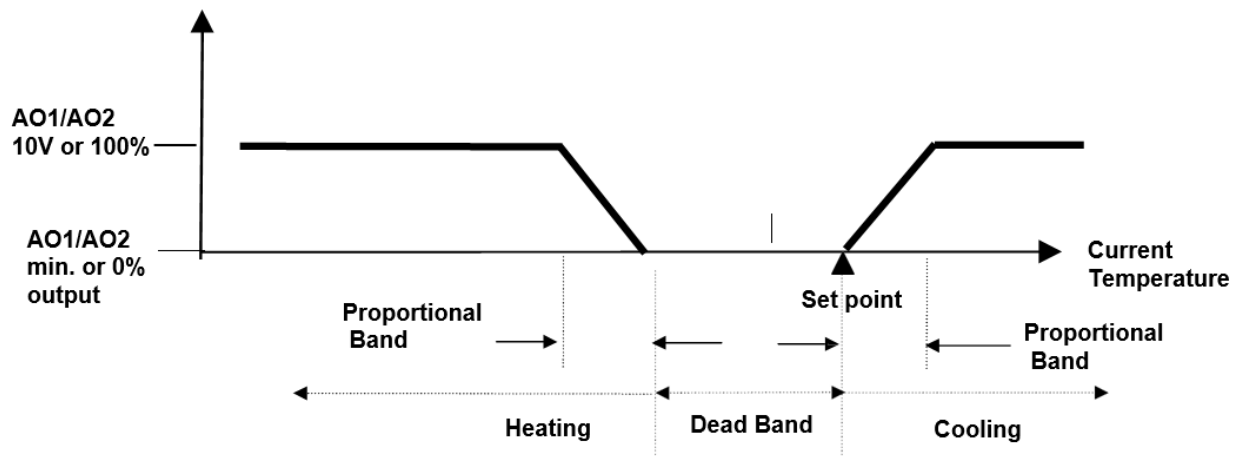

Floating Deadband

- The Heat and Cool temperature setpoints could be “attached” together. This means that as one setpoint is adjusted and “hits” against the deadband region, it will “push” the deadband region and the other setpoint along the temperature setpoint axis to allow for adjustment while maintaining the configured deadband. If the setpoint is adjusted back the other way, it will “pull” the deadband region and the other setpoint along the temperature setpoint axis.

Minimum Cooling Setpoint and Maximum Heating Setpoint



- Minimum Cooling Setpoint will be confined by set point low limit plus dead band and Minimum cooling setpoint [AV-39] Default 18°C/ 65°F
- Maximum Heating Setpoint will be confined by set point high limit minus dead band and Maximum heating setpoint [AV-40] Default 25°C/ 77°F

Fan Control Output

- *Lowest Fan Speed* is the speed the fan will default to after a control action (Heating or Cooling) with fan in AUTO mode. If the lowest fan speed [MSV4] is set as “Stop (1)”, the fan will automatically shut off after the control action plus a 2-minute fan-off time delay. During this delay, the AUTO icon will flash. If lowest fan speed is set to “Low (2)” the fan will run continuously after a control action
- *Fan Mode* can be toggled between AUTO or ON by using the FAN button on the thermostat or BACnet object [MSV0] *Fan Mode* (BACnet supervisor). By default, this value is set to “Auto(1)”, the AUTO icon is displayed and fan operation will be controlled automatically. To put the fan in ON mode set [MSV0] to “Low(2)”. This will cause the fan to run continuously (no AUTO icon is displayed). Fan icon spins when fan is active. The FAN button can be locked to limit user access to this feature or the BACnet supervisor can be programmed to default the thermostat to certain state at the end of an occupancy cycle.

Occupancy Setting

There are several ways to define thermostat occupancy state. **NOTE:** Occupancy will be detected by ESI contact by default.

1. Energy Savings Input (ESI) This is a dry contact input meant for communication from a customer supplied occupancy sensor. (default)
 2. Occupancy status (occupied/unoccupied) can be set by a BACnet supervisor using writable object *ESI Contact Definition* [BV14]. “0” for occupied, and “1” for unoccupied. E12/AV18 must be set with a value of 64 (disabled) in advance (E12/AV18 is set as 0 by default)
 3. User control of occupancy state is allowed from the SET button if E12/ AV18 Lock has the ESI Contact disabled. Pressing the SET button and UP/DOWN buttons will toggle the occupancy state. Press SET button to confirm. The SET button can work in conjunction with *BACnet occupancy Command* [BV14] on last-write-wins basis. The SET button could be locked to limit user control (use *Lock* [AV18] BACnet object or (LOC) engineering menu item to lock SET button). In this case only the BACnet supervisor can set occupancy states.
- *Occupancy Status* [B10] is a read-only BACnet object indicating current occupancy state -“0” for occupied, and “1” for unoccupied. (AV18 is set as 0 by default).
 - When in unoccupied state, a Moon () icon will be displayed on the LCD and the thermostat will change the set-point temperatures to the *Unoccupied Cool* and *Unoccupied Heat* setpoints [AV8 – 9]. When the state changes back to occupied, the thermostat will return to the occupied set-point values for *Cooling* and *Heating Temperature Setpoint* [AV0, AV3] and a sunlight icon () will be displayed to indicate occupied state on LCD

4.3 Engineering Mode Menu

Thermostat configuration can be performed using the engineering menu or by controlling BACnet objects using a BACnet client tool such as Contemporary Controls free BACnet Discovery Tool (BDT). It is highly suggested that engineering mode be operated by trained installers only, because it is related to system parameters that will affect the control results.

Operation of Engineering Menu

- At power “ON,” press and hold both the UP and DOWN buttons simultaneously for 5 seconds to enter Engineering Mode menu.
- Press the UP or DOWN buttons to rotate through the menu items. The last item loops back to first item at the end of items in menu. Press the MODE button to enter a submenu item.
- Press the UP or DOWN button to change the setting in the submenu item. Press the MODE button to confirm the setting and return to menu item selection. If no button is pressed for 10 seconds, the display will return to the menu item selection. After another 10 seconds, the display will return back to User mode. Settings are not changed unless confirmed using the MODE button.
- To leave Engineering Mode, rotate till (End) menu item appears and press the MODE button. Alternately, pressing no buttons for 10 seconds will return the thermostat back

to User mode.

Engineering Menu Flow Chart

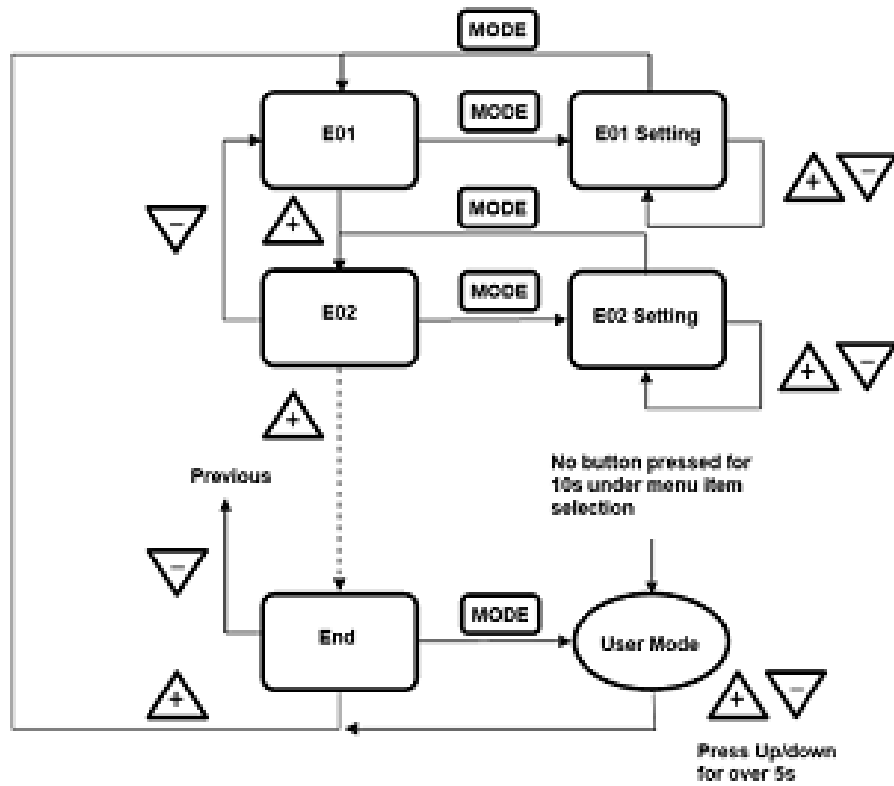

Engineering Menu Items Table BAST-421C-BW2

Item	Mnemonic	Description	°C Scale		°F Scale		Step
			Default	Range	Default	Range	
E1	db	Deadband	2.0	0~10	4.0	0~18	0.5 (°C/°F)
E2	ESIC	Unoccupied(ESI) cooling set point	28	25~35	82.5	77~95	1.0 (°C/°F)
E3	ESIH	Unoccupied(ESI) heating set point	15	10.0~22.0	59	50.0~72.0	1.0 (°C/°F)
E4	I-t	Integral Time and Output Cycle Time (seconds)	60	0~500	60	0-500	10 (Sec.)
E5	OPL1	Minimum output voltage in digital value for AO1 when reach Low limit	0(0V)	0~125	0(0V)	0~125	1 (LSB) (0.044V)
E6	SPA1	AO1 Span Offset	-20(10V)	-55~0	-20(10V)	-55~0	1 (LSB) (0.044V)
E7	SP-L	Low limit for temperature set point	10	0~50	50	32~122	1.0 (°C/°F)
E8	SP-H	High limit for temperature set point	30	0~50	95	32~122	1.0 (°C/°F)
E9	OFSt	Current temperature offset	0.0	-10.0~10.0	0.0	-18.0~18.0	0.1 (°C/°F)
E10	Pb	Proportional band or stage width	1.5	0~10.0	3.0	0~18.0	0.1 (°C/°F)
E11	diFF	Stage differential	0.5	0.1~1.0	1.0	0.1~1.8	0.1 (°C/°F)
E12	LOC	<p><i>Bit Definition:</i></p> <p>0: MODE button (dec=1)</p> <p>1: Down buttons (dec=2)</p> <p>2: Up button (dec=4)</p> <p>3: FAN SPEED button (dec=8)</p> <p>4: Power On/Off button (dec=16)</p> <p>5: SET (or °C/°F) button (dec=32)</p> <p>6: ESI contact detection (dec=64)</p> <p>7: Door/Window contact detection (dec=128)</p> <p>8: Modification for communication parameters (dec=256) i.e. baud rate, MAC addr, device inst.</p> <p>9: Control DOs by thermostat algorithm (0) or BACnet sup. (1) (dec=512)</p> <p>10~15: reserved/unused</p> <p><i>Bit Value</i></p> <p>0: Unlock / enable</p> <p>1: Lock / disable</p> <p><i>Examples (add dec values to lock multiples)</i></p> <p>Unlock/enable all (0)</p> <p>Lock MODE Button (1)</p> <p>Lock Down Button (2)</p> <p>Lock MODE & Down Buttons (3 = 1+2)</p> <p>Lock Power On/Off button (4)</p> <p>Lock MODE & Power & Down (7 = 1+2+4)</p> <p>Lock SET button (32)</p> <p>Lock MODE & Down & Power & SET (39 = 1+2+4+32)</p> <p>ESI contact disable (64)</p> <p>Lock the modification for communication parameters (256)</p> <p>DOs control commanded by BACnet (512)</p>	64	0-1023	64	0-1023	1

Item	Mnemonic	Description	°C Scale		°F Scale		Step
			Default	Range	Default	Range	
E13	ESI	ESI (DI1) digital sensor contact definition	0	0~1	0	0~1	0: N.O. 1: N.C.
E14	rE-C	Modulating Cooling direct/ reverse signal output	0	0~1	0	0~1	0 (direct) 1 (reverse)
E15	rE-H	Modulating Heating direct/ reverse signal output	0	0~1	0	0~1	0 (direct) 1 (reverse)
E16	rS	Present Temperature is getting from built-in temperature Sensor, remote temperature sensor, or assigned through communication	0	0~2	0	0~2	0: built-in 1: remote sense 2: assigned through BACnet
E17	-SP-	Display present temperature value of or current set-point for LCD	0	0~1	0	0~1	0: display PV 1: display SP
E18	door	Door or Windows contact definition (not applicable to all models)	0	0~1	0	0~1	0: N.O. 1: N.C.
E19	LFAn	Lowest Fan speed in Auto fan mode	0	0~1	0	0~1	0: stop 1: low
E20	Pct	Output Percentage (not used)	0	0~100	0	0~100	1%
E21	devH	Device instance no. - Hi bytes	100	0~4194	100	0~4194	1
E22	dEUL**	Device instance no. - Low bytes	1	0~999 (if ID-H <= 4193) 0~302 (if ID-H = 4194)	1	0~999 (if ID-H <= 4193) 0~302 (if ID-H = 4194)	1
E23	UdP**	UDP port number	47808 (BAC0)	0~65535 (0~FFFF)	47808 (BAC0)	0~65535 (0~FFFF)	1
E24	rHSt	Relative Humidity Offset	0		0	-30.0~30.0	0.1%RH
E25	F-Ht	Fan Output for Heating	0	0/1	0	0/1	0: Disable 1: Enable
E26	dLyC	Cooling Stage Delay	3	1~3	3	1~3	1 (minutes)
E27	cycC	Cooling Maximum Cycles per Hour	4	2~6	4	2~6	1 (cycles/hour)
E28	dLyH	Heating Stage Delay	3	0~3	3	0~3	1 (minutes)
E29	cycH	Heating Maximum Cycles per Hour	4	2~255	4	2~255	1 (cycles/hour)

Item	Mnemonic	Description	°C Scale		°F Scale		Step
			Default	Range	Default	Range	
E30	tyPE	Control Type	2	1~2	2	1~2	1: 4-Pipe cooling or heating Manual Changeover 2: 4-Pipe heating and cooling auto Changeover
E31	OPL2	Minimum Output for AO2	0(0V)	0~125	0 (0v)	0~125	1 (LSB) (0.044V)
E32	SPA2	Span Offset for AO2	0(0V)	0~125	0 (0v)	0~125	1 (LSB) (0.044V)
E33	Hrtr	Communication Heartbeat Minimum Rate	60	10~3600	60	10~3600	10s
E34	rhPB	Humidity Control PB					
E35	rhdF	Humidity Control Diff.					
E37	CO2F	CO2 Offset Value					
E38	AFtH	After Hour Extension Time <i>(not used)</i>					
E39	VALL	Input Low Value of Valve Feedback <i>(not used)</i>					
E40	VALH	Input High Value of Valve Feedback <i>(not used)</i>					
E41	OPts	Options <i>(not used)</i>					
E42	diAb	DI contact Defination <i>(not used)</i>					
E43	Hrt	Communication Heartbeat Flip-Flop	0	0/1	0	0/1	0: Off 1: On
E44	CSPL	Minimum Cooling Temperature Setpoint	18.0	0.0- 50.0	65.0	32.0-122.0	0.1(°C/°F)
E45	HSPH	Maximum Heating Temperature Setpoint	25.0	0.0-50.0	77.0	32.0-122.0	0.1(°C/°F)
E46	nFAn	Minimum Fan Output <i>(not used)</i>					
E47	hFAn	Maximum Fan Output <i>(not used)</i>					
E48	FAnL	Low Fan Speed Setting <i>(not used)</i>					
E49	FAn2	Med. Fan Speed Setting <i>(not used)</i>					
E50	FAnH	Hi Fan Speed Setting <i>(not used)</i>					
E51	ObAb	Humidity Control PB <i>(not used)</i>					
E52	OFFt	Minimum Off Time	180	0~600	180	0~600	5 (seconds)
E53	On-t	Minimum On Time	0	0~600	0	0~600	5 (seconds)
E54	It-2	Integral Time and Output Cycle Time 2	60	0~500	60	0~500	10 (Seconds)
E55	Phy1	MAC address 1st & 2nd bytes		hhhh		hhhh	h: 0~F in hex
E56	Phy2	MAC address 3rd & 4th bytes		hhhh		hhhh	h: 0~F in hex

Item	Mnemonic	Description	°C Scale		°F Scale		Step
			Default	Range	Default	Range	
E57	Phy3	MAC address 5th & 6th bytes		hhhh		hhhh	h: 0~F in hex
E58	IP-1	1st byte of IPv4 address	192	0~255	192	0~255	1
E59	IP-2	2nd byte of IPv4 address	168	0~255	168	0~255	1
E60	IP-3	3rd byte of IPv4 address	0	0~255	0	0~255	1
E61	IP-4	4th byte of IPv4 address	1	0~255	1	0~255	1
E62	tEst	Self-Diagnostic – toggle all LCD features and all relays. Use only to test				Use Caution!	Press MODE to engage test
E63	boot	Reset Wi-Fi parameters to factory defaults					Press MODE to reset
E64	rSt	Reset all parameters including communication and control algorithm to the factory defaults				Use Caution!	Press MODE to reset
E65	End	Exit Engineer Mode Menu					Press MODE to exit engineering menu

**** NOTE:**

1. Changing these values needs to unlock modification for communication parameters in advance. Please refer to the parameter LOC(Lock, AV17) for details.
2. Device instance number = “devH” *1000 + “devL” = 0~4194302. ex. If “devH” is 100 and devL” is 001 then the Device instance number = 100001.

Lock Function Setup and Examples

The 16-bit binary encoded decimal register accessed through *Lock* [AV17] BACnet object and LOC engineering menu item is used to enable/disable features in the thermostat. The first 10 bits are used (bit 0 ~ bit 9), bits 10~15 are reserved/unused. Bits are represented by their decimal values and are added or subtracted to toggle from “0” to “1”. Add a bit’s decimal value to toggle to “1” or subtract a bit’s decimal value to toggle to “0”. See table below.

Bit Definition:	Decimal Value to Write:	Add decimal values to lock multiples. Bold decimal number is the example value to write to Lock object. Examples:
0: MODE button	(dec=1)	Unlock/enable all (0) – this will also enable ESI DI1 (add 64 to all values below to maintain default occupancy selection over BACnet). Lock MODE button (1) Lock DOWN button (2) Lock MODE & DOWN (3 = 1+2) Lock UP button (4) Lock MODE & DOWN & UP (7 = 1+2+4) Lock FAN SPEED button (8) Lock MODE & DOWN & UP & FAN (15 = 1+2+4+8) Lock POWER button (16) Lock MODE & DOWN & UP & FAN & POWER (31 = 1+2+4+8+16) Lock SET button (32) Lock MODE & DOWN & UP & FAN & POWER & SET (63 = 1+2+4+8+16+32) ESI contact disable (64 – default). When the default value of 64 is maintained, occupancy is set over BACnet and SET user button. Lock MODE & DOWN & UP & FAN & POWER & SET & disable ESI DI1 (127 = 1+2+4+8+16+32+64) Door/Window contact detection (unused) Lock the modification for communication parameters such as baud rate and mac address (256) Lock MODE & DOWN & UP & FAN & POWER & SET & disable ESI DI1 & modification for communication parameters (383 = 1+2+4+8+16+32+64+256) DOs control commanded by BACnet (512)
1: DOWN button	(dec=2)	
2: UP button	(dec=4)	
3: FAN SPEED button	(dec=8)	
4: POWER On/Off button	(dec=16)	
5: SET (or °C/°F) button	(dec=32)	
6: ESI contact detection	(dec=64)	
7: Door/Window contact detection (unused)	(unused)	
8: Modification for communication parameters i.e., baud rate, MAC addr, device inst.	(dec=256)	
9: Control DOs by thermostat algorithm (0) or BACnet sup. (1)	(dec=512)	
10~15: reserved/unused	(unused)	
Bit Value:		
0: Unlock / enable		
1: Lock / disable		

4.4 BACnet Objects and Network Configuration

Transmission types

- Physical layer: Wi-Fi 802.11 b/g/n
- Protocol: BACnet/IP
- UDP Port Number: BAC0 (47808)
- MAC address: Wi-Fi chip MAC address found written on the back side of thermostat or in Engineering Menu item (Phy3). This can assist when multiple Wi-Fi thermostats are installed.
- Device Instance: 700001

Initial Configuration

All configuration parameters are settable through use of the buttons on thermostat by entering the *Engineer Menu*, or once installed on the BACnet network, configuration can also be altered using BACnet commands. Network command-based configuration can also be accomplished using a Wi-Fi enabled laptop/computer/tablet/smart phone and Contemporary Controls' free [BACnet Discovery Tool](#).

Wi-Fi Communication Configuration

Overview

The BAST-421C-BW2 Wi-Fi thermostat is preconfigured with a *BACnet Device Instance* of 700001 and a *UDP Port Number* of 47808 (decimal) equivalent to *BAC0* (hexadecimal).

Addressing

A unique *Device Instance Number* throughout the entire BACnet internetwork is required to distinguish the device from all other BACnet devices. When more than one BASstat is installed at the same time, their *Device Instance Number* must be configured prior to connecting to the BACnet/IP network or BACnet communication will fail due to duplicate device instances.

Device instance can be modified in *Engineering Menu* items (dEVH) – high bytes and (dEVL) – low bytes. Device Instance = (dEVH)*1000+(dEVL). Device Instance example: if (dEVH) is set to 4194 and (dEVL) is set to 7, *Device Instance Number* = 4194007. *Device Instance Number* can also be changed by writing to BACnet object [AV21] *Device Instance* once the thermostat is online. The BACnet UDP Port Number can be configured in *Engineering Menu* item (UDP).

BACnet/IP Wi-Fi (BW2) model will initially boot up as a Wi-Fi Access Point to allow for IP configuration. This requires connecting to the thermostat as an access point for initial configuration using a Wi-Fi enabled laptop/computer/tablet/smart phone. Look for the BAST-421C-BW2 with its unique SSID of "WiFi-788C-xxxx" and no access point passphrase by default (simply click to connect to Access Point). The digits "xxxx" in "788C-xxxx" are the last 4 digits of the thermostat's Wi-Fi chip MAC address found written on the back side of the Wi-Fi module.

This ensures a unique SSID for discovery and configuration and it can assist in identification of thermostats when multiple Wi-Fi stats are installed on the same site (unique identifier outlined in blue in the image below). This unique identifier can also be viewed in *Engineering Menu* item (Phy3).



Once connected to the thermostat as an access point, open its web page by typing its default address of **192.168.0.1** with **admin** for username and **no password**. Web page pictured below will be presented for IP Network Configuration. The default IP configuration is shown below.

Network Configuration

Device ID: WiFi-122B-1a9f
MAC Address: d0ba-e414-1a9f

Network Mode : Access Point Infrastructure

Device SSID :

Device Passphrase : (None or at least 8 alphanumeric)

Channel : ▼

IP Address :

Network Mask :

Gateway :

As Foreign Device

Save & Restart

After initial connection using laptop or tablet or smart phone, the Wi-Fi mode in the thermostat can be changed to *Infrastructure* mode. The local Wi-Fi router/access point can be selected from the *Available AP* drop-down list, or an *AP SSID* can be entered manually. Enter the *AP Passphrase* to authenticate and connect to the AP.

ATTENTION: Once connected to the Wi-Fi access point, the Wi-Fi thermostat will use the Wi-Fi access point credentials. To ensure a secure connection, when setting up the Wi-Fi router (Access Point) the thermostats will be connected to, make sure you set up a strong access point passphrase (password) and encryption method! This is required for Wi-Fi client devices to connect to the Wi-Fi router securely and it is essential to cyber security. Creating a good Wi-Fi password is the first step in creating a secure environment that is inaccessible to unauthorized parties. Use the following tips when creating a Wi-Fi access point passphrase:

- Passphrase should be a minimum of eight characters (maximum 15 characters), the more

random the better. Use a mix of letters (uppercase and lowercase), numbers, and symbols.

- Do not reuse or repeat passwords across router installations or job sites.
- Change Wi-Fi password regularly (not required but very secure). Provides guidelines for building maintenance personnel.
- Disable broadcast of SSID. This is a very simple setting which stops the broadcast of the access point SSID, and only authorized parties who know the SSID can connect to it. This is configured in the Wi-Fi router.
- Store passwords in a safe place, limit access to authorized parties only, and provide instructions for password reset and reconfiguring a strong password in cases of reconfiguring the network in the future.

Choose an option for DHCP addressing using the radio buttons.

Network Configuration

Device ID: WiFi-122B-1a9f
MAC Address: d0ba-e414-1a9f

Network Mode : Access Point Infrastructure

Available AP : ▼

AP SSID

AP Passphrase (None or at least 8 alphanumeric)

DHCP : Enable Disable

The thermostat supports DHCP addressing and will acquire an IP address from the router/access point automatically if you chose *Enable* next to DHCP. If you chose *Disable*, you must assign an *IP Address*, *Network Mask*, and *Gateway Address* within the Wi-Fi router IP subnet manually.

Network Configuration
Device ID: WiFi-122B-1a9f
MAC Address: d0ba-e414-1a9f

Network Mode : Access Point Infrastructure

Available AP : ▼

AP SSID

AP Passphrase (None or at least 8 alphanumeric)

DHCP : Enable Disable

IP Address :

Network Mask :

Gateway :

Save & Restart

A reboot of the thermostat is required for new IP configuration to take effect. Click the *Save & Restart* button to reboot the thermostat, and you will be prompted to confirm the restart. Click *OK* to Save New Settings and Restart or click *Cancel* to revisit IP configuration.

192.168.0.1 says

Save New Settings and Restart WiFi Module?

When *OK* is clicked, a confirmation is displayed to indicate configuration is stored in the thermostat's EEPROM. After reboot, the new thermostat credentials will be *admin* for user name and the newly configured Access Point's password for password.

Click *OK* on the confirmation message and wait 20 seconds for the reboot process to complete.

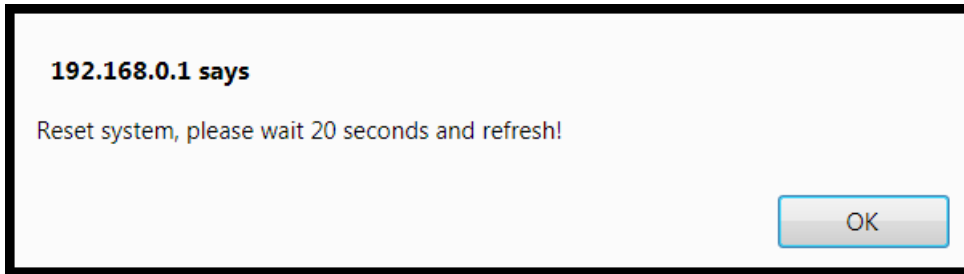

While rebooting, the thermostat will display “DP” icon in the lower right corner to indicate it is in the process of searching and connecting to the AP. Once the “DP” stops flashing, the thermostat has successfully connected to Wi-Fi access point. After reboot of the thermostat, the new *Infrastructure* mode with new IP settings will be used. The thermostat will now be connected to the local Wi-Fi network AP selected in configuration screen and will not show up as an access point itself any longer. If you are unsure of the thermostat’s IP address, it could be viewed through the *Engineering Menu* in items (*IP-1*) for the first octet, (*IP-2*) for the second octet, (*IP-3*) for the third, and (*IP-4*) for the fourth octet of the IP address, or if you have access to the Wi-Fi access point, its “statistics” or “connected devices” web page will show the BASstat BW2’s IP address as well as MAC address (the same address in Engineering Menu items *Phy1*, *Phy2*, and *Phy3* and the printed MAC on the back of the thermostat Wi-Fi module (outlined in blue above).

Reset Settings

The BASstat will store configuration in the event of power loss. If configuration fails or the thermostat needs to be configured to use a different Wi-Fi access point, the thermostat must be reset and reconfigured. There are 2 reset settings options for the Wi-Fi thermostat:

- Boot will restore Wi-Fi communication parameters to default, but it will maintain control algorithm settings. Select (boot) engineering menu item and press MODE to confirm.
- Reset will restore all values to default and can be selected from engineering menu (rSt).

Foreign Device Registration (FDR)

Communication across IP subnets requires a Broadcast Management Device (BBMD) device or support for Foreign Device Registration (FDR) feature. The BASstat supports the FDR feature to register with a remote BBMD which could be a BACnet client or a BMS headend. To communicate with BACnet clients across subnets, the BAST-421C-BW2 can do FDR registration with a remote BBMD. The BACnet BBMD feature requires a BACnet device with BBMD capability, such as a BACnet router or other, to be installed and configured on the network. BBMD allows discovery of all BACnet/IP devices in the IP subnet instead of just the FDR device.

- Select As Foreign Device.
- The BBMD IP is the address of the BBMD device on the remote network. Enter the address of the BBMD with which the BAST-421C-BW2 will perform Foreign Device Registration (FDR) if there is no local BBMD device in the same subnet as the BAST-421C-BW2 providing communication to the remote subnet.

Enter the UDP port for BBMD.

- Time to Live is the BBMD registration time. Specify the seconds between successive FDR registrations. Recommended value is 100.

Network Configuration

Device ID: WiFi-122B-1a9f
MAC Address: d0ba-e414-1a9f

Network Mode : Access Point Infrastructure

Device SSID :

Device Passphrase : (None or at least 8 alphanumeric)

Channel :

IP Address :

Network Mask :

Gateway :

As Foreign Device

BBMD IP :

BBMD Port :

Time To Live :

Save & Restart

A reboot of the thermostat is required for new IP configuration to take effect. Click the *Save & Restart* button to reboot the thermostat, and you will be prompted to confirm the restart. Click *OK* to Save New Settings and Restart or click *Cancel* to revisit IP configuration.

192.168.0.1 says

Save New Settings and Restart WiFi Module?

When *OK* is clicked, a confirmation is displayed to indicate configuration is stored in the thermostat's EEPROM. After reboot, the new thermostat credentials will be *admin* for user name and the newly configured Access Point's password for password.

Click *OK* on the confirmation message and wait 20 seconds for the reboot process to complete.

BACnet Object Table BAST-421C-BW2

Object name	Type & Instance	Object Property (Readable/Writable)	Range
BACnet Thermostat	Device 700001	Model Name (R)	788C
		Application Software Version (R)	Aug 6 2021
		Object Identifier (R)	
		Object Name (R/W)	32 characters (max.)

Object name	Type & Instance	Readable/ Writable	Description	Range and Definition
Current Temperature	AI 0	R	Current Temperature	-999~9999: -99.9~999.9 °C/°F
Active Temperature Setpoint	AI 1	R	Active Temperature Set-Point	°C :0~500 (0.0~50.0°C) °F : 320~1220 (32.0~122.0°F)
Built-in Temperature Sensor	AI 2	R	Built-in Temperature Sensor Reading	-999~9999: -99.9~999.9 °C/°F
Remote Temperature Sensor	AI 3	R	Remote Temperature Sensor Reading	-999~9999: -99.9~999.9 °C/°F
Current Humidity	AI 4	R	Current Humidity	0~1000: 0.0~100.0%RH

Current Dew Point	AI 5	R	Current Dew Point	-999~9999: -99.9~999.9 °C/°F
Current CO ₂ Reading	AI 6	R	Current CO ₂ Reading	0~3000: 0~3000 ppm
Control Valve Feedback	AI 7	R	Control Valve Feedback	0~1000 (0.0%~100.0%)
Modulating/ Floating Output 1	AI 8	R	Modulating/ Floating Output 1 (Cooling)	0~100: 0~100 %
Modulating/ Floating Output 2	AI 9	R	Modulating/ Floating Output 2 (Heating)	0~100: 0~100 %
Modulating Fan Output	AI 10	R	Modulating Fan Output	0~100: 0~100 %
Control Output Percentage	AI 11	R	CO ₂ Control Output Percentage	0~100: 0~100 %
Voltage Input Value	AI 12	R	Voltage Input Value	0~150 (0.0~15.0 VDC)
AI 1 Percentage	AI 13	R	Analog Input 1 Percentage Value	0~1000 (0.0%~100.0%)
2 nd Remote Temperature	AI 14	R	2 nd remote temperature Value	-999~9999: -99.9~999.9°C /°F
3rd Remote Temperature	AI 15	R	3rd Remote Temperature Sensor Reading Value	-999~9999: -99.9~999.9°C /°F
Cooling Temperature Setpoint	AV 0	R/W	Cooling Temperature Set Point	°C :0~500 (0.0~50.0°C) °F: 320~1220 (32.0~122.0°F)
Temperature Override	AV 1	R/W	Assigned Current Temperature	-999~9999 (-99.9~999.9°C/°F)
Timer Off	AV 2	R/W	Timer Off (Only for Models with Countdown Timer Function Available).	0~24: 0~24 Hours Count Down 0: Disable
Heating Temperature Setpoint	AV 3	R/W	Heating Temperature Set Point	-999~9999: -99.9~999.9 °C/°F
Hr-Running Time	AV 4	R/W	Running Time of Valve (Hr.)	0~65535 (Hr.) For Reading But 0~30000 (Hr.) For Writing.
M-Running Time	AV 5	R/W	Running Time of Valve (M.)	0~59 (Minute)
Sec-Running Time	AV 6	R/W	Running Time of Valve (Sec.)	0~59 (Sec.)
Deadband	AV 7	R/W	Deadband	0-18° (default 4°)
Unoccupied Cool Setpoint	AV 8	R/W	Unoccupied Cooling Setpoint	°C: 250~300 (25.0~30.0°C) °F: 770~860 (77.0~86.0°F)
Unoccupied Heat Setpoint	AV 9	R/W	Unoccupied Heating Setpoint	°C: 100~220 (10.0~22.0°C) °F: 500~715(50.0~71.5°F)

Integral-Cycle Time	AV 10	R/W	Integral Time and Output Cycle Time	0~500 (Sec.)
Analog Minimum Output for AO1	AV 11	R/W	Minimum Output Voltage in Digital Value When Reach Low Limit for AO1	0~125 (LSB)
Span Offset for AO1	AV 12	R/W	Span Offset for AO1	-55~0 (LSB)
Low Setpoint Limit	AV 13	R/W	Low Limit for Set-Point Temperature	°C :0~500 (0.0~50.0°C) °F: 320~1220(32.0~122.0°F)
High Setpoint Limit	AV 14	R/W	High Limit for Set-Point Temperature	°C :0~500 (0.0~50.0°C) °F: 320~1220(32.0~122.0°F)
Temperature Offset	AV 15	R/W	Offset for Current Temperature	°C: -100~100 (- 10.0~10.0°C) °F: -180~180 (-18.0~18.0°F)
Proportional Band-Stage Width	AV 16	R/W	Proportional Band or Stage Width	°C :0~100 (00~10.0 °C) °F: 0~180 (00~18.0 °F)
Stage Differential	AV 17	R/W	Stage Differential	°C :1~10 (0.1~1.0 °C) °F: 1~18 (0.1~1.8 °F)
Lock	AV 18	RW	LOCK	<p><i>Bit Definition:</i></p> <ul style="list-style-type: none"> 0: MODE button (dec=1) 1: Down button (dec=2) 2: Up button (dec=4) 3: FAN SPEED button (dec=8) 4: Power On/Off button (dec=16) 5: SET (or °C/°F) button (dec=32) 6: ESI contact detection (dec=64) 7: Door/Window contact detection (dec=128) 8: Modification for communication parameters (dec=256) i.e. baud rate, MAC addr, device inst. 9: Control DOs by thermostat algorithm (0) or BACnet sup. (1) (dec=512) 10~15: reserved/unused <p><i>Bit Value</i></p> <ul style="list-style-type: none"> 0: Unlock / enable 1: Lock / disable <p><i>Examples (add dec values to lock multiples) For more details see Lock Function Setup and Examples section of this manual</i></p>

Modulating/floating Control Out Percentage	AV 19	R/W	Percentage of Modulating/ Floating Control Output	0~100 (0%~100%)
Device Instance	AV 20	R/W	Device Instance	0~4194302 (NOTE: Changing this value needs to unlock modification for communication parameters in advance. i.e., AV17=0~255 or 512~768. Please refer to LOCK(AV17) for details)
UDP Port No	AV 21	R/W	UDP Port Number	0~65535
Humidity Offset	AV 22	R/W	Humidity Offset Value <i>(CH models only)</i>	-300~300 (-30.0~30.0 %RH)
Cooling Short Cycle Delay	AV 23	R/W	Cooling Short Cycle Delay	1~3 Minutes
Cooling Maximum Cycles per Hour	AV 24	R/W	Cooling Maximum Cycles per Hour	2~6 Cycles
Heating Short Cycle	AV 25	R/W	Heating Short Cycle Delay	0~3 Minutes
Heating Maximum Cycles per Hour	AV 26	R/W	Heating Maximum Cycles per Hour	2~8 Cycles
Analog Minimum Output for AO2	AV 27	R/W	Minimum Output Voltage in Digital Value When Reach Low Limit for AO2	0~125 (LSB)
Span Offset for AO2	AV 28	R/W	Span Offset for AO2	-55~0 (LSB)
Heartbeat Rate	AV 29	R/W	Communication Heartbeat Minimum Rate	10~3600 s
Humidity Proportional Band-Stage Width	AV 30	R/W	Proportional Band or Stage Width for Humidity Control Output	0~1000 (0.0~100.0) %RH
Humidity Stage Differential	AV 31	R/W	Stage Differential for Humidity Control Output	0~1000 (0.0~100.0) %RH
Proportional Band or Stage Width 2	AV 32	R/W	Proportional Band or Stage Width 2	°C :0~100 (00~10.0 °C) °F: 0~180 (00~18.0 °F)
CO ₂ Offset	AV 33	R/W	CO ₂ Offset Value	-1000~2000 ppm
After Hour Extension Run Time	AV 34	R/W	After Hour Extension Run Time	5~20(0.5~2.0) Hour
Input Low Value	AV 35	R/W	Input Low Value	-1000~1000 (-100.0~100.0 %)
Input High Value	AV 36	R/W	Input High Value	0~1000 (0.0~100.0 %)
Options	AV 37	R/W	Options	Bit Definition --- Bit 0: T or SP Bit 1~15: Reserved
DI Contact Definition	AV 38	R/W	DI Contact Definition	Bit Definition --- Bit 0: DI-1 1: DI-2 Bit 2~15: Reserved *Bit value:0-NO, 1-NC

Minimum Cooling Setpoint	AV 39	R/W	Minimum Cooling Setpoint	°C:0~500 (0.0~50.0°C) °F: 320~1220 (32.0~122.0°F)
Maximum Heating Setpoint	AV 40	R/W	Maximum Heating Setpoint	°C:0~500 (0.0~50.0°C) °F: 320~1220 (32.0~122.0°F)
Minimum Fan Output	AV 41	R/W	Minimum Fan Output at Auto Fan Mode (for Modulating Fan Application)	0%~Reg 51
Maximum Fan Output	AV 42	R/W	Maximum Fan Output at Auto Fan Mode (for Modulating Fan Application)	Reg 50~100%
Low Fan Speed Setting	AV 43	R/W	Low Fan Speed Setting (for Modulating Fan Application)	0%~Reg 53
Med. Fan Speed Setting	AV 44	R/W	Med. Fan Speed Setting (for Modulating Fan Application)	Reg 52~Reg54
Hi Fan Speed Setting	AV 45	R/W	Hi Fan Speed Setting (For Modulating Fan Application)	Reg 53~100%
Minimum Off Time	AV 46	R/W	Minimum Off Time	0~600 seconds
Minimum On Time	AV 47	R/W	Minimum On Time	0~600 seconds
Integral-Cycle Time 2	AV 48	R/W	Integral Time and Output Cycle Time 2	0~500 (Sec.)
Set Point for Humidity	AV 49	R/W	Set Point for Humidity Control	0~1000 (0.0~ 100.0%RH)
Dew Point Set Point	AV 50	R/W	Dew Point Temperature Set Point	-999~9999: -99.9~999.9 °C/°F
Occupancy Status	BI 0	R	Status of Occupancy	0: Room Occupied 1: Room Unoccupied
Window-Door Status	BI 1	R	Window/ Door Status	0: Door/Window Closed 1: Door/Window Open
Cooling-heating Status	BI 2	R	Status of Cooling/Heating Control Output	0: Close & Off 1: Open & On
Relay 1 Status	BI 3	R	Status of Relay 1	0: Off, 1: On
Relay 2 Status	BI 4	R	Status of Relay 2	0: Off, 1: On
Relay 3 Status	BI 5	R	Status of Relay 3	0: Off, 1: On
Relay 4 Status	BI 6	R	Status of Relay 4	0: Off, 1: On
Relay 5 Status	BI 7	R	Status of Relay 5	0: Off, 1: On
Relay 6 Status	BI 8	R	Status of Relay 6	0: Off, 1: On

Relay 7 Status	BI 9	R	Status of Relay 7 Fan	0: Off, 1: On
DI 1 Status	BI10	R	Status of Digital Input 1	0: Off, 1: On
DI 2 Status	BI11	R	Status of Digital Input 2	0: Off, 1: On
DI 3 Status	BI12	R	Status of Digital Input 3	0: Off, 1: On
DI 4 Status	BI13	R	Status of Digital Input 4	0: Off, 1: On
DI 5 Status	BI14	R	Status of Digital Input 5	0: Off, 1: On
DI 6 Status	BI15	R	Status of Digital Input 6	0: Off, 1: On
DI 7 Status	BI16	R	Status of Digital Input 7	0: Off, 1: On
Fan Status	BI17	R	Fan Status	0: Off, 1: On
Flow Switch Status	BI18	R	Differential Pressure (Air Flow) Switch Status	0: Off, 1: On
Trip Status	BI19	R	Trip Alarm Status	0: Off, 1: On
Filter Status	BI20	R	Filter Dirty Alarm Status	0: Off, 1: On
Smoke/ Fire Alarm Status	BI21	R	Smoke/ Fire Alarm Status	0: Off, 1: On
Status	BI22	R	Current Status	0: Off, 1: On
Valve Status	BI23	R	Valve Status	0: Off, 1: On
Alarm	BI24	R	Alarm Status	0: Off, 1: On
Frozen Alarm Status	BI25	R	Frozen Alarm Status	0: Off, 1: On
After Hour Status	BI26	R	After Hour Status	0: Normal Hour 1: After Hour
Occupancy Contact Definition	BV 0	R/W	Occupancy(DI1) Contact Definition (this feature is model specific)	0: N.O. = Occupied 1: N.C. = Occupied
Cooling Direct-Reverse Acting	BV 1	R/W	Modulating Cooling Direct/Reverse Signal Output	0: Direct (0 To10v) 1: Reverse (10 To 0V)
Heating Direct-Reverse Acting	BV 2	R/W	Modulating Heating Direct/Reverse Signal Output	0: Direct (0 To10v) 1: Reverse (10 To 0V)
Reversing Valve Polarity	BV 3	R/W	Reversing Valve Polarity	Cooling/ Heating 0: N.O./ N.C. 1: N.C./ N.O.
Window-Door Contact Definition	BV 4	R/W	Door or Windows(DI2) Contact Definition	0: N.O. 1: N.C.

On-Off Control	BV 5	R/W	On/Off Status of Thermostat	0: Off, 1: On
Temperature Scale	BV 6	R/W	°C/ °F	0: °C 1: °F
Relay 1 Control	BV7	R/W	On/Off Control of Relay 1	0: Off, 1: On
Relay 2 Control	BV8	R/W	On/Off Control of Relay 2	0: Off, 1: On
Relay 3 Control	BV9	R/W	On/Off Control of Relay 3	0: Off, 1: On
Relay 4 Control	BV10	R/W	On/Off Control of Relay 4	0: Off, 1: On
Relay 5 Control	BV11	R/W	On/Off Control of Relay 5	0: Off, 1: On
Relay 6 Control	BV12	R/W	On/Off Control of Relay 6	0: Off, 1: On
Relay 7 Control	BV13	R/W	On/Off Control of Relay 7 (Fan)	0: Off, 1: On
Occupancy Command	BV 14	R/W	Room Occupancy Setting	0: Occupied, 1: Unoccupied
Fan Output for Heating	BV15	R/W	Disable/ Enable Fan Output for Heating	0: Disable 1: Enable
Heartbeat	BV16	R/W	Communication Heartbeat Flip-Flop	0: Off 1: On
Fan Mode	MSV 0	R/W	Fan Mode	1: Auto 2: Low 3: Med. 4: Hi
System Mode	MSV 1	R/W	Working Mode: Heat, Cool or Ventilation	1: Cool Mode 2: Heat Mode 3: Ventilation @ Cool Mode 4: Ventilation @ Heat Mode
Sleep	MSV 2	R/W	Sleep (Only for Models with Sleep Function Available).	1: Disable, 2: 0 Hr. Sleep 3: 0.5 Hr. Sleep 4: 1 Hr. Sleep 5: 1.5 Hrs. Sleep, 6: 2 Hrs. Sleep
Temperature Source	MSV3	R/W	Current Temperature Source	1: Built-In Temp. Sensor 2: Remote Temp. Sensor 3: Assigned through BACnet
Lowest Fan Speed	MSV 4	R/W	Lowest Fan speed in Auto Fan mode	1: Stop 2: Low 3: Med. 4: Hi
Fan Speed Status	MSV 5	R	Fan Speed Status	0: Stop 1: Low 2: Med 3: Hi
Display Options	MSV 6	R/W	LCD Display Options	1: T & Time (if available) 2: SP & Time (if available) 3: T & CO2 (if available) 4: CO2 & Time (if available)

				5: SP & CO2 (if available) 6: T & RH (if available) 7: T & Valve (if available)
Control Type	MSV 7	R/W	Control Type Selection	2: 4-Pipe Cooling or Heating Manual Changeover 3: 4-Pipe Cooling and Heating Auto Changeover

5 Warranty

Contemporary Controls (CC) warrants this product to the original purchaser for two years from the product shipping date. Product returned to CC for repair is warranted for one year from the date the repaired product is shipped back to the purchaser or for the remainder of the original warranty period, whichever is longer.

If the product fails to operate in compliance with its specification during the warranty period, CC will, at its option, repair or replace the product at no charge. The customer is, however, responsible for shipping the product; CC assumes no responsibility for the product until it is received.

CC's limited warranty covers products only as delivered and does not cover repair of products that have been damaged by abuse, accident, disaster, misuse, or incorrect installation. User modification may void the warranty if the product is damaged by the modification, in which case this warranty does not cover repair or replacement.

This warranty in no way warrants suitability of the product for any specific application. IN NO EVENT WILL CC BE LIABLE FOR ANY DAMAGES INCLUDING LOST PROFITS, LOST SAVINGS, OR OTHER INCIDENTAL OR CONSEQUENTIAL DAMAGES ARISING OUT OF THE USE OR INABILITY TO USE THE PRODUCT EVEN IF CC HAS BEEN ADVISED OF THE POSSIBILITY OF SUCH DAMAGES, OR FOR ANY CLAIM BY ANY PARTY OTHER THAN THE PURCHASER.

THE ABOVE WARRANTY IS IN LIEU OF ANY AND ALL OTHER WARRANTIES, EXPRESSED OR IMPLIED OR STATUTORY, INCLUDING THE WARRANTIES OF MERCHANTABILITY, FITNESS FOR PARTICULAR PURPOSE OR USE, TITLE AND NONINFRINGEMENT.

6 Returning Products for Repair

Return the product to the location where it was purchased or follow the instructions at the URL below:

www.ccontrols.com/rma.htm

7 Declaration of Conformity

Additional compliance documentation can be found on our website.

www.ccontrols.com



United States
Contemporary Control
Systems, Inc.

Tel: +1-630-963-7070
Fax: +1-630-963-0109

info@ccontrols.com

China
Contemporary Controls
(Suzhou) Co. Ltd

Tel: +86 512 68095866
Fax: +86 512 68093760

info@ccontrols.com.cn

United Kingdom
Contemporary Controls
Ltd

Tel: +44 (0)24 7641 3786
Fax: +44 (0)24 7641 3923

info@ccontrols.co.uk

Germany
Contemporary Controls
GmbH

Tel: +49 341 520359 0
Fax: +49 341 520359 16

info@ccontrols.de

www.ccontrols.com

