

EchoPro®

Radar Liquid & Solid Level Transmitter



LR36, LR41 & LR46 Series Quick Start



©2020 Flowline, Inc.
All Rights Reserved

WELCOME TO THE ECHOPRO® QUICK START

The EchoPro® Quick Start Guide is meant to show the basic configuration settings to get the EchoPro® up and running quickly. If you run into an issue that is not addressed here or wish to install or set up with a non-standard configuration, please address the EchoPro® Manual or refer to the Flowline website at www.flowline.com.

WE DO YOUR LEVEL BEST

Thank you for purchasing EchoPro®. The sensor provides level measurement for your tank application. This Quick Start includes everything you'll need to get the sensor up and running.

SENSOR MODELS

Offered in three different models, EchoPro® is an intrinsically safe, two-wire, pulse radar level sensor that provides a continuous 4-20 mA current output that's proportional to the media level in a tank or sump. Make sure that the model purchased is appropriate for your application.

SOLIDS LEVEL TRANSMITTERS

Series	Max Range	Beam Angle	Material	Mounting	FCC Compliance	Application
LR36	49.2' (15m)	8° (4" horn)	316L SS	1-1/2" NPT 4" flanged gimbal	Part 15.256, Class B	Solids with normal temperature and normal pressure under 32.8' (10m)
LR41	229.7' (70m)	8° (4" horn)	316L SS	1-1/2" NPT 4" flanged gimbal	Part 15.256, Class B	Solids with dew / dust / crystal under 98.4' (30m)
LR46	229.7' (70m)	5° (8" parabolic)	316L SS	1-1/2" NPT 4" flanged gimbal 4", 8" or 10" flange	Part 15.256, Class B	Solids with strong dew / dust / crystal or ranges over 98.4' (30m)
		4° (10" parabolic)				

FCC CONFORMITY

- ⚠ This instrument complies with Part 15 of the FCC Rules. Operation is subject to the following two conditions: (1) this instrument may not cause harmful interference, and; (2) this instrument must accept any interference received, including interference that may cause undesired operation.
- ⚠ Changes or modifications not expressly approved by the manufacturer could void the user's authority to operate the equipment.
- ⚠ **Warning:** User must keep a safety distance of at least 20cm from the antenna.
- ⚠ **NOTE: LR36 (4" horn), LR41 (4" horn) & LR46 (8" and 10" parabolic) series:** This equipment has been tested and found to comply with the limits for a Class B digital device, pursuant to Part 15 of the FCC Rules. These limits are designed to provide reasonable protection against harmful interference in a residential installation. This equipment generates uses and can radiate radio frequency energy and, if not installed and used in accordance with the instructions, may cause harmful interference to radio communications. However, there is no guarantee that interference to radio and television reception, which can be determined by turning the equipment off and on, the user is encouraged to try to correct the interference by one or more of the following measures:
 - Reorient or relocate the receiving antenna.
 - Increase the separation between the equipment and the receiver.
 - Isolate the equipment to an outlet different from where the receiver is connected.
 - Consult the dealer or an experienced technician for help.

USING THE DISPLAY

The display module features a dot matrix LCD display with 4 push buttons on a removable puck. Out of the box, the display indicates level in feet and depicts the level within the 4-20mA span on a bar graph at the right side of the display. The four buttons perform the following functions:

<ul style="list-style-type: none"> • ESCAPE <ul style="list-style-type: none"> ○ Exit configuration mode ○ Return to a higher menu level ○ Display Echo Curve 	<ul style="list-style-type: none"> • Up Arrow <ul style="list-style-type: none"> ○ Modify parameter values ○ Choose display mode
<ul style="list-style-type: none"> • Right Arrow <ul style="list-style-type: none"> ○ Choose configuration options ○ Choose parameter digits to edit ○ Display contents of parameters 	<ul style="list-style-type: none"> • OK <ul style="list-style-type: none"> ○ Enter Menu and Options ○ Confirm configuration options ○ Confirm changes to parameters



MENU INTRODUCTION

- 1) To enter the Main Menu (from the Main Screen), press the **OK** button.
- 2) Use the **Right Arrow** button to scroll through the Main Menu options.
 - a) Configuration - Below are the configuration menu functions:
 - i) Empty Configuration
 - ii) Full Configuration
 - iii) Medium
 - iv) Dampening
 - v) Output Mapping
 - vi) Scaled Units
 - vii) Scaling
 - viii) Range
 - ix) Dead Band
 - x) Sensor ID
 - b) Display - This menu function sets the display mode and contrast.
 - c) Diagnostics - Below are the diagnostic menu functions:
 - i) Measurement of Peak Values
 - ii) Measurement Status
 - iii) Echo Curve
 - iv) Simulation
 - d) Service - Within the service menu functions, you can store a False Echo Curve, set units of measurement, change output settings, reset configuration settings, set language or set a PIN for the sensor.
 - e) Info - This item provides information on the sensor's type, serial number, date of manufacture and software version.
- 3) To select one of the functions, press **OK**.
- 4) To exit the programming mode, press **ESC**.

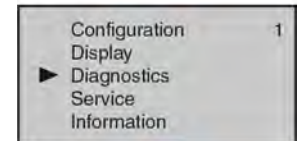
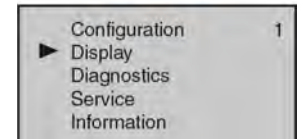
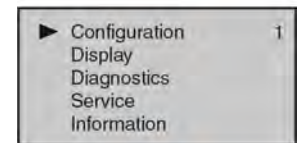

BASIC CONFIGURATION OVERVIEW

Below are the 9 basic steps to configure the sensor for operation. Each step is described in detail on the following pages

1) Measure the Tank

- a) Begin by measuring the key tank and fitting dimensions. Correct tank dimensions will result in accurate sensor measurement.

2) Set the Units of Measurement

- a) Units can be configured in basic engineering units of length including Feet or Meters.

3) Set the Empty Configuration

- a) This is the empty setting (4mA) for the tank.

4) Set the Full Configuration

- a) This is the full setting (20mA) for the tank.

5) Set the Range (Maximum Range or MaxR)

- a) This is the maximum measurement range for the sensor. The sensor will ignore all echo returns beyond this setting.

6) Set the Dead Band (Minimum Range or MinR)

- a) This is the minimum measurement range for the sensor. The sensor will ignore all echo returns closer than this setting.

7) Check the Echo Curve

- a) This is a quick diagnostic tool to determine if the sensor is reading the correct level.

8) Install the Sensor

- a) Review the installation requirements to assist in the mounting of the sensor.

9) Wire the Sensor

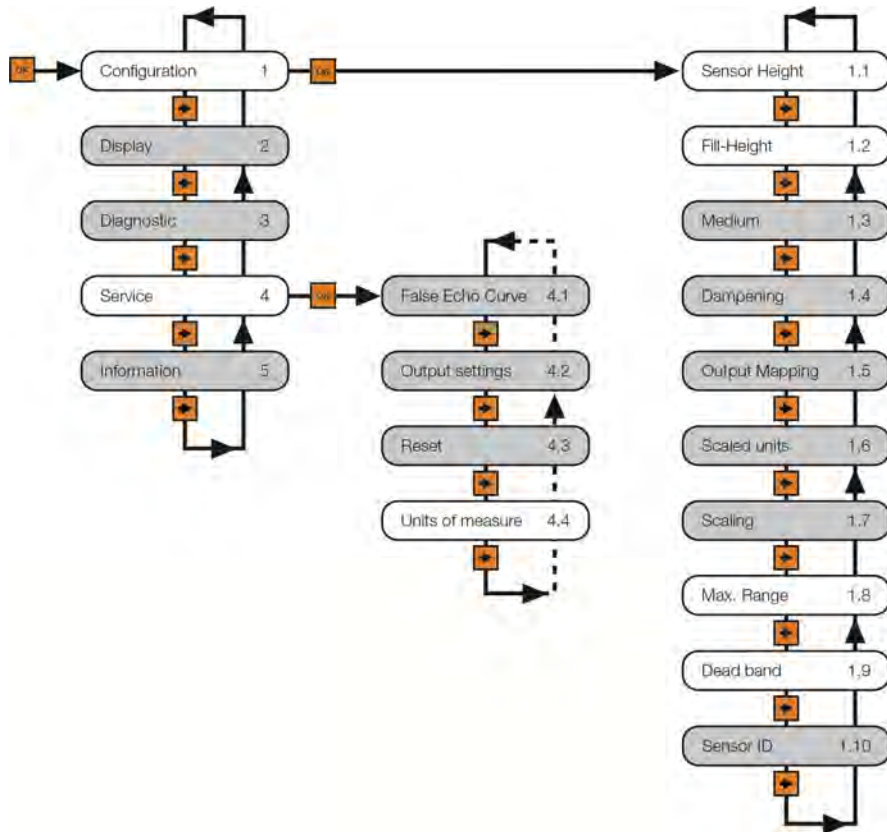

STEP 1 – MEASURE THE TANK

Measuring the tank is one of the most important aspects in configuring the sensor. When measuring the tank, take into account the location of the sensor with respect to fittings, risers, dome tops and bottoms, and identify where the measurements are taken from the sensor. **Note:** The location for measurement may be different among different sensor Series, based upon the type of antenna. Refer to the Measurement Reference Chart for the measurement location of your sensor. The basic measurements for configuration are described below:

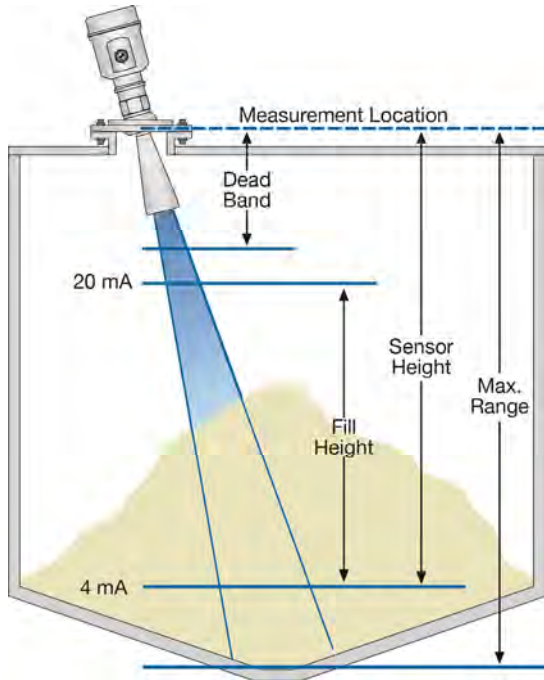

- 1) Distance from the sensor's measurement location to the bottom of the tank is the **Max. Range** value. The Range value is typically set at the bottom of the tank.
- 2) Distance from the sensor's measurement location to the empty or lowest liquid level in the tank is the **Sensor Height**.
 - a) Sensor Height = 4mA setting.
 - b) With flat bottom tanks, the Range and Sensor Height values can be the same.
- 3) Distance from the sensor's measurement location to the full or highest liquid level in the tank is the **Fill-Height**.
 - a) Fill-Height = 20mA setting.

Measurement Reference Chart

LR36 & LR41 Series

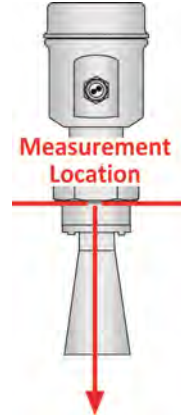

LR46 Series

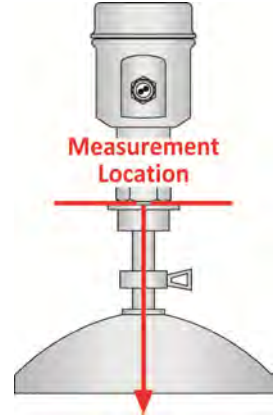

STEP 2 – SET THE UNITS OF MEASUREMENT

This function sets the units for all measurement values to be entered into the sensor. The choices for units are feet and meters. The unit is shipped with a default setting of feet.

1. From the Main Screen, press **OK** to advance into the Main Menu.
2. Press **Right Arrow** repeatedly until the arrow is next to Service.
3. Press **OK** to advance into the Service menu (Echo curve will appear).
4. Press **Right Arrow** repeatedly until the menu shows Units of Measurement.
5. Press **OK** to advance into Units of Measurement.
6. Press **Right Arrow** to change the setting between feet [ft (d)] and meters [m (d)].
7. When the units are correct, press **OK** to save the setting.
8. When done, press **ESC** to return to the Main Menu, and press **ESC** a second time to return to the Main Screen.

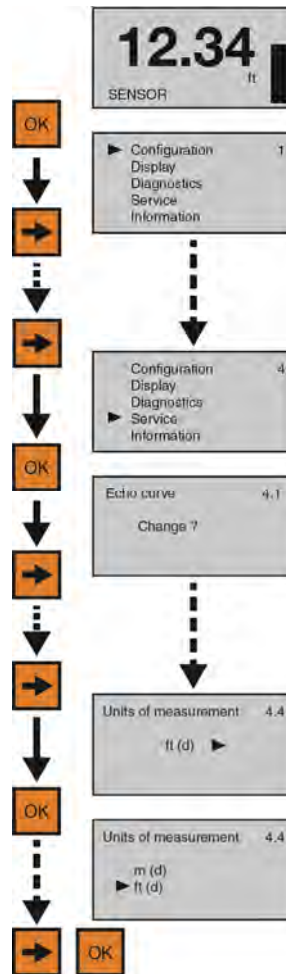

STEP 3 – SET THE SENSOR HEIGHT (4mA)

This function sets the Sensor Height point corresponding to an empty position in the tank. The measured distance of Sensor Height from the sensor will set the 4mA location as well as establish the 0% span of the sensor.

1. From the Main Screen, press **OK** to advance into the Main Menu.
2. Press **OK** to advance into the Configuration Menu.
3. Press **OK** to advance into Empty Configuration. The first percentage segment will be highlighted.
4. Press **OK** again to switch to the distance (d) setting.
5. Press **Right Arrow** to move one segment to the right. **Right Arrow** will scroll left to right and then back to the first segment.
6. Press **Up Arrow** to increase the value of the number highlighted. **Up Arrow** will scroll from 0 to 9 and back again.
7. When the value is correct, press **OK** to save the setting.
8. When done, press **ESC** to return to the Main Menu, and press **ESC** a second time to return to the Main Screen or; if you want to advance directly into Full Configuration, press **Right Arrow**.

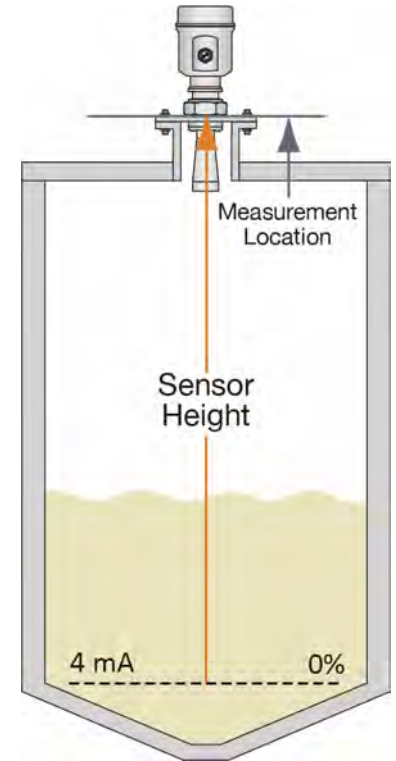

STEP 4 – SET THE FILL-HEIGHT (20mA)

This function sets the Fill-Height point corresponding to a full position in the tank. The measured distance of Fill-Height from the 0% or empty position will set the 20mA location as well as establish the 100% span of the sensor.

1. From the Main Screen, press **OK** to advance into the Main Menu.
2. Press **OK** to advance into the Configuration Menu.
3. Press **Right Arrow** to advance into Full Configuration.
4. Press **OK** to advance into Full Configuration. The first percentage segment will be highlighted.
5. Press **OK** again to switch to the distance (d) setting.
6. Press **Right Arrow** to move one segment to the right. **Right Arrow** will scroll left to right and then back to the first segment.
7. Press **Up Arrow** to increase the value of the number highlighted. **Up Arrow** will scroll from 0 to 9 and back again.
8. When the value is correct, press **OK** to save the setting.
9. When done, press **ESC** to return to the Main Menu, and press **ESC** a second time to return to the Main Screen or; if you want to advance directly into Range, press **Right Arrow** repeatedly until Range appears.

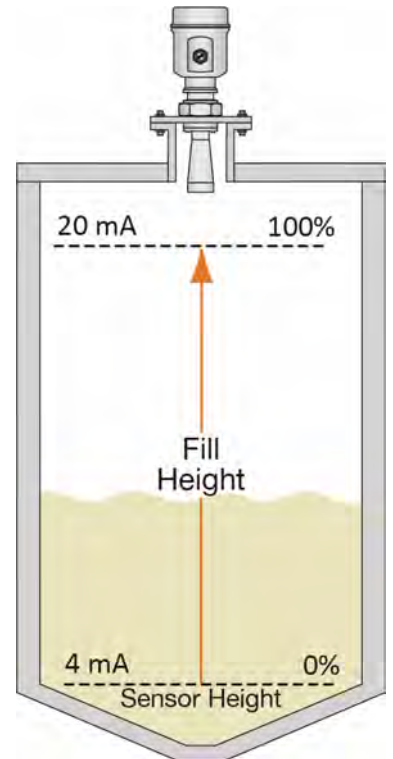
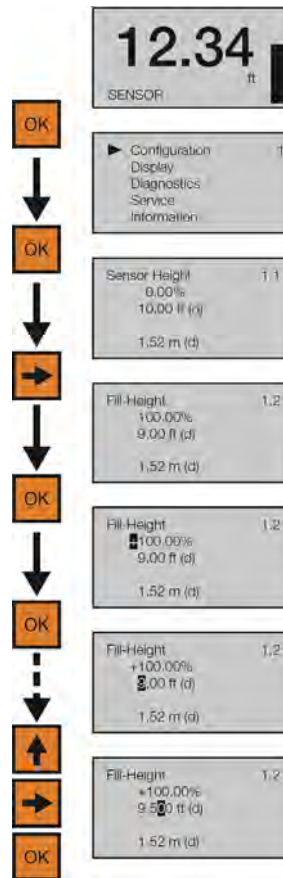

STEP 5 - SET THE MAX. RANGE (MAXIMUM RANGE)

This function sets the maximum operational range for the sensor. This setting defines the maximum distance that the sensor will detect valid echo returns.

1. From the Main Screen, press **OK** to advance into the Main Menu.
2. Press **OK** to advance into the Configuration Menu.
3. Press **Right Arrow** repeatedly until the menu shows Range.
4. Press **OK** to edit Range value. The first segment will be highlighted.
5. Press **Right Arrow** to move one segment to the right. **Right Arrow** will scroll left to right and then back to the first segment.
6. Press **Up Arrow** to increase the value of the number highlighted. **Up Arrow** will scroll from 0 to 9 and back again.
7. When the value is correct, press **OK** to save the setting.
8. When done, press **ESC** to return to the Main Menu, and press **ESC** a second time to return to the Main Screen or; if you want to advance directly into Dead Band, press **Right Arrow** repeatedly until Dead Band appears.

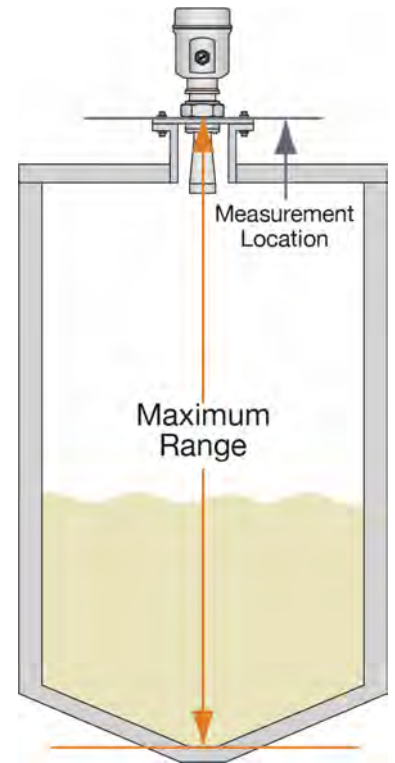

STEP 6 - SET THE DEAD BAND

This function sets the Dead Band for the sensor. This setting defines the minimum distance that the sensor will detect valid echo returns. While the Dead Band setting is typically configured to be equal with or slightly above (higher in the tank) the Full Configuration setting (20 mA), its functions independently of Full Configuration. **Note:** If the Dead Band setting is placed below the Full Configuration setting, then the sensor will not measure above the Dead Band.

Dead Band Equals Full Config.

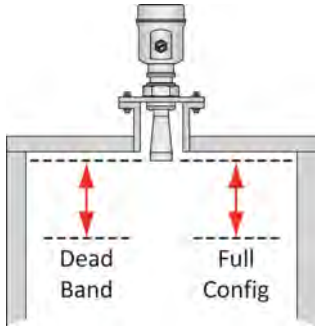

Dead Band Below Full Config.

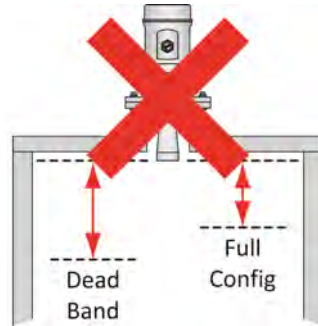

Dead Band Above Full Config.

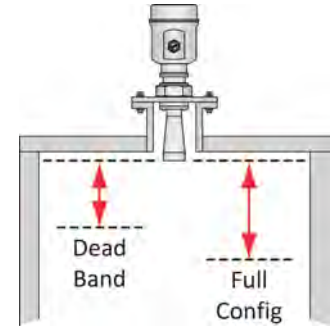

1. From the Main Screen, press **OK** to advance into the Main Menu.
2. Press **OK** to advance into the Configuration Menu.
3. Press **Right Arrow** repeatedly until menu shows Dead Band.
4. Press **OK** to edit Dead Band value. The first segment will be highlighted.
5. Press **Right Arrow** to move one segment to the right. **Right Arrow** will scroll left to right and then back to the first segment.
6. Press **Up Arrow** to increase the value of the number highlighted. **Up Arrow** will scroll from 0 to 9 and back again.
7. When the value is correct, press **OK** to save the setting.
8. When done, press **ESC** to return to the Main Menu, and press **ESC** a second time to return to the Main Screen.

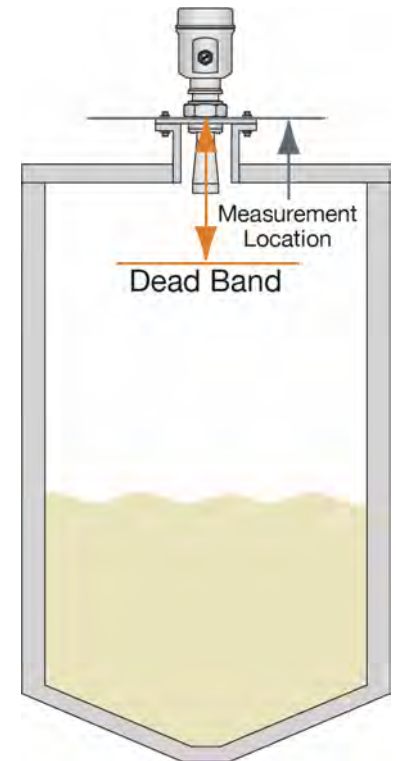
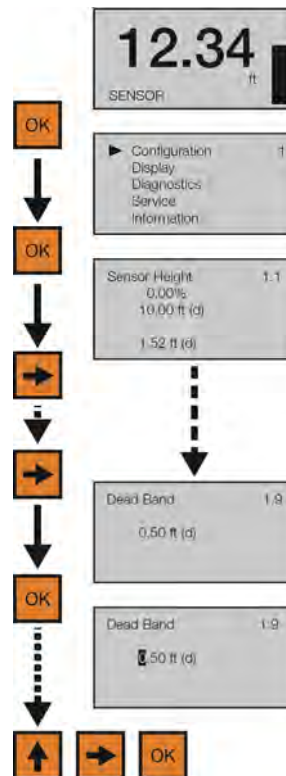

STEP 7 – CHECK THE ECHO CURVE

This function displays the primary echo return(s) that the sensor is seeing graphically, the location and amplitude of the return(s), and the numeric air gap distance from the sensor's measurement location to the liquid level below.

Note: This step should only be performed after having completed the prior six configuration steps with the sensor installed on the tank. Additionally, if the sensor was installed in a stand pipe or sight glass, now go forward to Section Six and turn on the still well function (Sensor Installed in a Stand Pipe or Sight Glass) before continuing with this step.

1. From the Main Screen, press **ESC** and the Echo Curve Screen will appear. The curve graphically represents the primary echo return(s) amplitude (Y-axis) over distance (X-axis). Above the echo return peak is a floating arrow and triangle symbol (which under normal conditions are often merged together or seen as a single triangle because it's the larger of the two symbols). The arrow represents the measured liquid level and the triangle represents the peak amplitude location of the echo return. Under normal conditions, expect to see a stable triangle (or overlapping arrow and triangle) floating above a pronounced peak at the expected air gap distance between the measurement location and liquid level.
2. In the upper right hand corner of the screen are two lines of numbers that represent the air gap distance from the measurement location to the liquid level (arrow) on the top, and peak amplitude location (triangle) of the echo return on the bottom. Under normal conditions, these values should be relatively close to one another and consistent with the expected air gap distance between the measurement location and liquid level.
3. Assuming that the sensor is properly installed, if the measured liquid level and peak amplitude location data (symbols and values) are unstable, substantially different from one another and/or inconsistent with the actual air gap distance, then this likely indicates that the sensor requires additional process adjustment(s) described in the following Section Six.
4. When done, press **ESC** to return to the Main Menu.

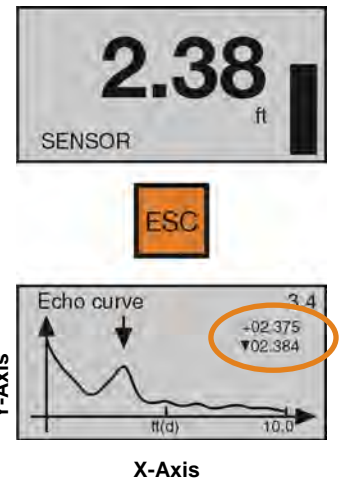

STEP 8 – INSTALL THE SENSOR (INSTALLATION REQUIREMENTS)

In order to measure as much of the solids volume as possible, the antenna must be aimed at the lowest point within the tank. With any cylindrical shaped tank with a cone bottom, the sensor should be mounted a distance of half the radius ($\frac{1}{2}R$) from the side wall. If $\frac{1}{2}R$ cannot be met, it is preferred to mount the sensor closer to the side wall and away from the center of the tank.

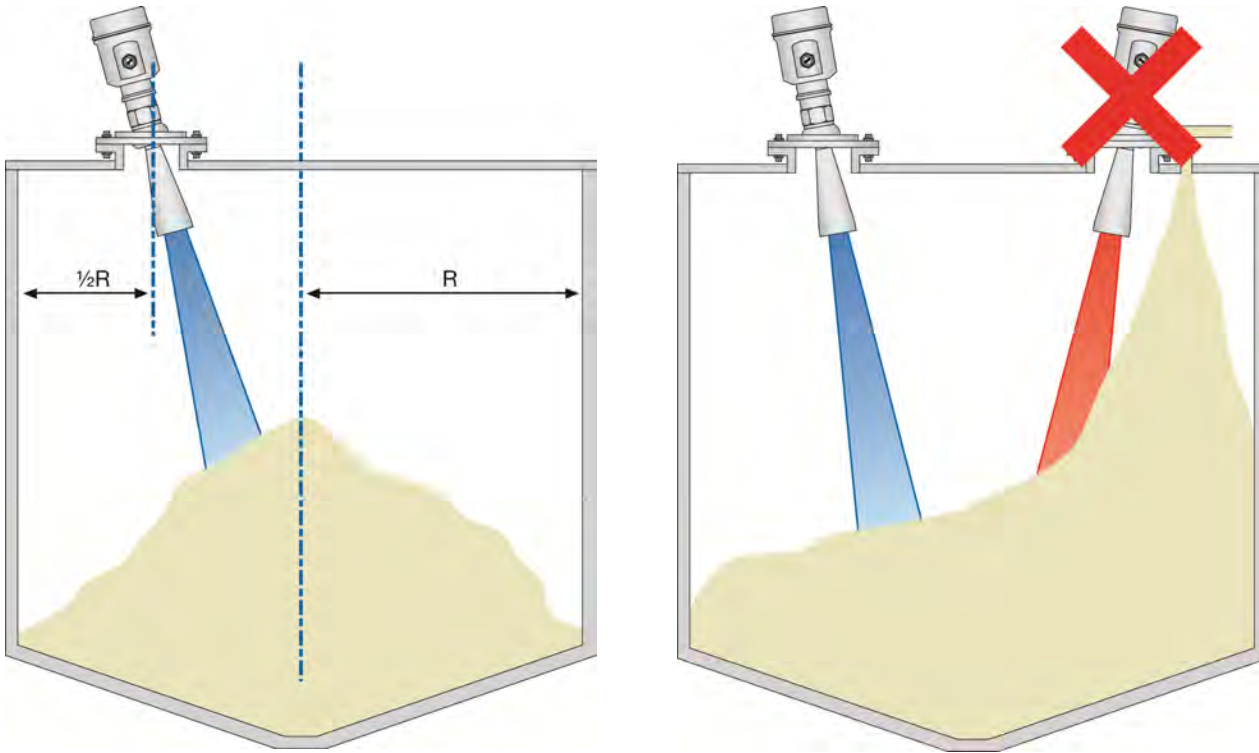

Avoid installing the sensor above the filling stream to avoid interference to the radar pulse. Locate the sensor away from the filling stream.

Be aware of antenna's length and width when using a gimbaled mount. The freedom of movement for the gimbaled becomes less as the riser's height increases.

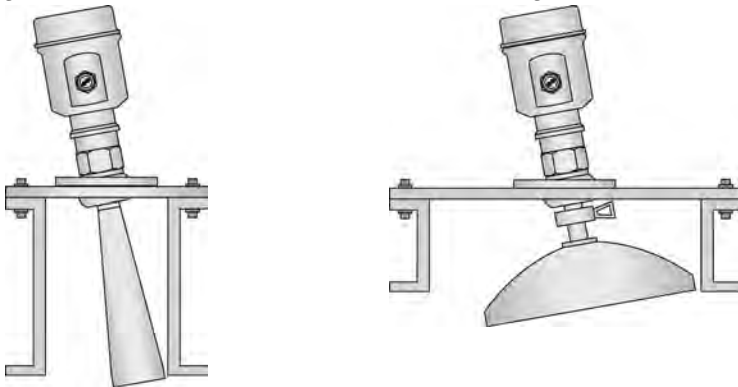

When using the gimballed flange, the sensor can easily be mounted to direct the signal energy towards center of the tank. The angle of the sensor will be dependent on the distance down to the bottom of the tank and the distance away from the bottom of the cone. Use the chart below to understand the angle required to direct the signal to the bottom of the cone.

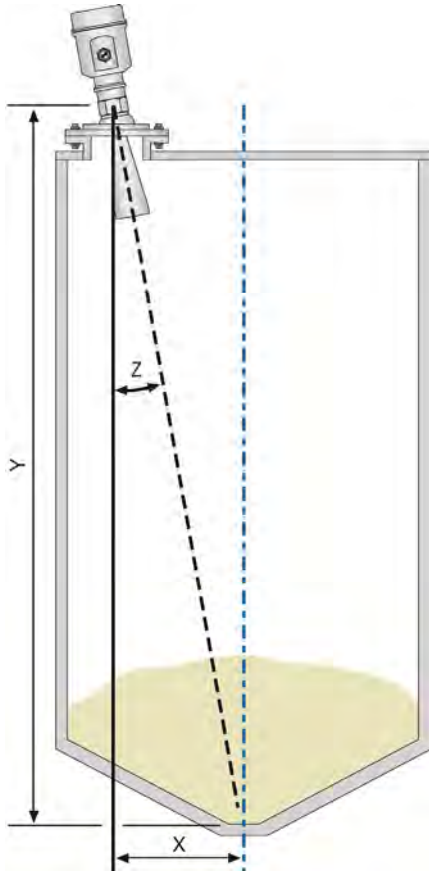

Distance (Y)	2° (Z)	4° (Z)	6° (Z)	8° (Z)	10° (Z)
10'	0.35'	0.70'	1.05'	1.41'	1.76'
20'	0.70'	1.40'	2.10'	2.81'	3.53'
30'	1.05'	2.10'	3.15'	4.22'	5.29'
40'	1.40'	2.80'	4.20'	5.62'	7.05'
50'	1.75'	3.50'	5.26'	7.03'	8.82'
60'	2.10'	4.20'	6.31'	8.43'	10.58'
70'	2.44'	4.89'	7.26'	9.84'	12.34'
80'	2.79'	5.59'	8.41'	11.24'	14.11'
90'	3.14'	6.29'	9.46'	12.65'	15.87'
100'	3.49'	6.99'	10.51'	14.05'	17.63'

Distance from Cone Bottom (X)

Distance (Y)	2° (Z)	4° (Z)	6° (Z)	8° (Z)	10° (Z)
5m	0.17m	.35m	0.53m	0.70m	0.88m
10m	0.35m	0.70m	1.05m	1.41m	1.76m
15m	0.52m	1.05m	1.58m	2.11m	2.65m
20m	0.70m	1.40m	2.10m	2.81m	3.53m
25m	0.87m	1.75m	2.63m	3.51m	4.41m
30m	1.05m	2.10m	3.15m	4.22m	5.29m

Distance from Cone Bottom (X)

EXAMPLE:

If the EchoPro® is 40' (Y-distance) above the bottom of the cone and the transmitter is 7.0' (X-distance) from the Center-line of the cone bottom, then the transmitter will be angled 10° (Z-angle) off-center.

Most Smart Phones have a built-in Spirit Level which will show the angle of the sensor. Remove the Cap from the EchoPro® and activate the Spirit Level App or any equivalent App for your SmartPhone. Place the Smart Phone on the display of the transmitter and adjust the sensor to its required angle.

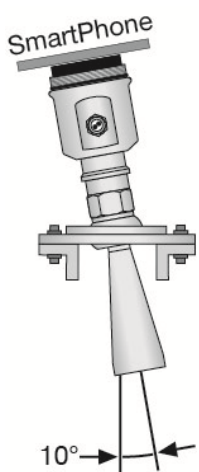

SmartPhone with Spirit Level



BEAM ANGLE

The emitted microwave pulse will expand along its specified beam angle for the entire height of the tank. Place the sensor so that objects will not interfere with the beam path underneath the sensor. The beam angle is a function of the sensor Series and antenna length (where variable). Verify the beam angle specification of your sensor and reference the below charts to determine the amount of free measurement space required under the installed sensor.

Beam Angle	4°	5°	6°	8°	12°
Height	Diameter				
10'	0.70'	0.87'	1.05'	1.40'	2.10'
20'	1.40'	1.75'	2.10'	2.80'	4.20'
30'	2.10'	2.62'	3.14'	4.20'	6.31'
40'	2.79'	3.49'	4.19'	5.59'	8.41'
50'	3.49'	4.37'	5.24'	6.99'	10.51'
60'	4.19'	5.24'	6.29'	8.39'	12.61'
70'	4.89'	6.11'	7.34'	9.79'	14.71'
80'	5.59'	6.99'	8.39'	11.19'	16.82'
90'	6.29'	7.86'	9.43'	12.59'	18.92'
100'	6.98'	8.73'	10.48'	13.99'	21.02'

Beam Angle	4°	5°	6°	8°	12°
Height	Diameter				
5m	0.35m	0.44m	0.52m	0.70m	1.05m
10m	0.70m	0.87m	1.05m	1.40m	2.10m
15m	1.05m	1.31m	1.57m	2.10m	3.15m
20m	1.40m	1.75m	2.10m	2.80m	4.20m
25m	1.75m	2.18m	2.62m	3.50m	5.26m
30m	2.10m	2.62m	3.14m	4.20m	6.31m

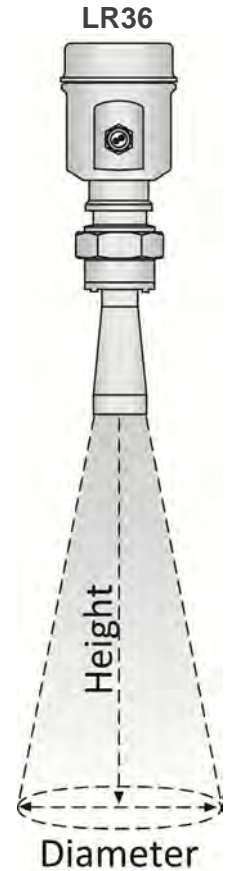

AVOID CONDENSATION IN THE CONDUIT

You can give your instrument additional protection against moisture penetration by leading the conduit connection or cable downward in front of the cable entry. Condensation in the conduit will therefore not enter the sensor's enclosure.



ANTENNA PREPARATION

In order to fit the antenna into an application, it may be best to attach the sensor to a flange before mounting inside the tank. The antenna can be removed and the sensor mounted to the flange with the antenna re-attached afterwards.

LR36 and LR41 Horn Antenna

- 1) Loosen and remove the four (4) socket screws using a 3mm Allen wrench.
- 2) Carefully remove the antenna. **Note:** Do not remove or damage the plastic cone (microwave RF emitter) within the antenna socket.
- 3) Insert the antenna through the bottom of the fitting. **Note:** If doing so from the inside of the tank, make sure to secure it, so as to prevent the antenna from falling into the tank.
- 4) Connect the sensor to the antenna socket and reattach the four (4) screws using a 3mm Allen wrench.
- 5) Attach the sensor to the fitting as necessary.

Add a Flange

Remove Screws



Remove Antenna

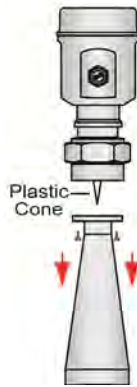

Insert Antenna

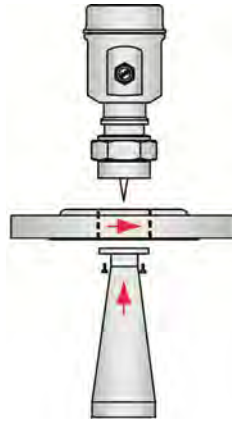

Connect Antenna to Sensor, Attach Screws

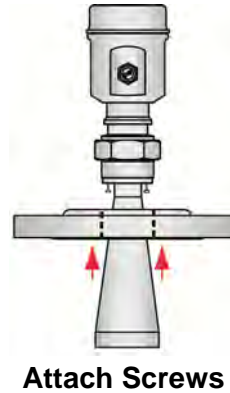

Thread Sensor to Flange

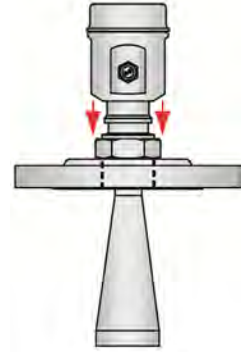

LR46 Parabolic Antenna

- 1) Loosen and remove the tri-clamp connector.
- 2) Carefully remove the antenna.
- 3) Insert the antenna through the bottom of the flange. **Note:** If doing so from the inside of the tank, make sure to secure it, so as to prevent the parabolic antenna from falling into the tank.
- 4) Connect the sensor to the parabolic antenna socket and reattach the tri-clamp connector.
- 5) Attach the sensor to the fitting as necessary.

Add a Flange to the Parabolic Antenna

Uncrew Tri-Clamp

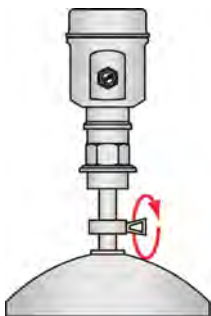

Remove Parabolic

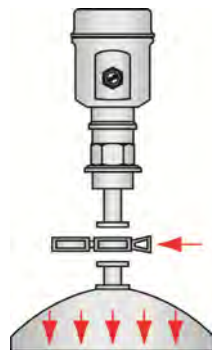

Insert Flange

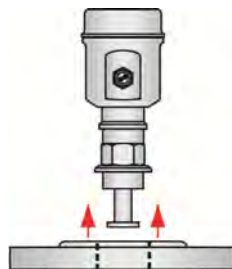

Connect Antenna to Sensor, Attach Screws

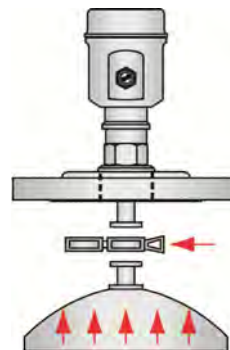

Thread Sensor to Reducer Bushing

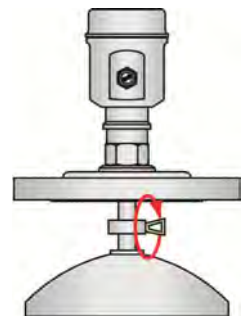

STEP 9 – WIRE THE SENSOR

Remove the Display: To access the terminal strip and conduit ports, you first need to remove the display. Gently twist the display counter-clockwise until you feel the display unlock from the housing. Next, lift the display from the housing to view the terminal strip and wire access ports.

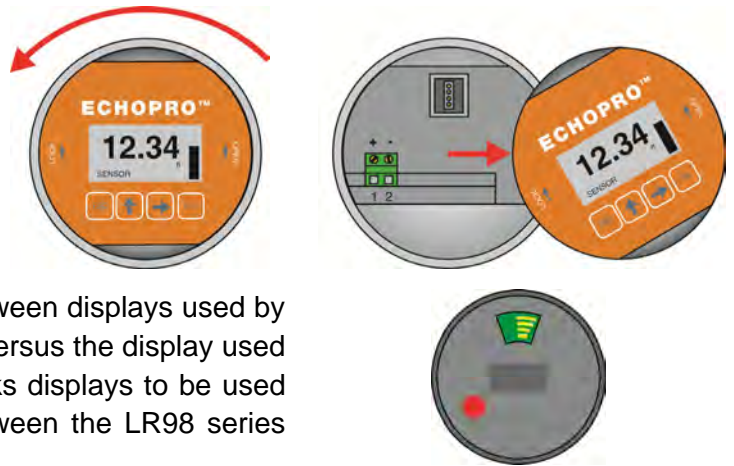

Note: There is an internal configuration difference between displays used by the EchoPro® sensors (LR36, LR41 and LR46 series) versus the display used with the LR98 series. A colored dot on the back marks displays to be used only with the LR98 series. Never swap displays between the LR98 series and other EchoPro® sensors.

Supply Voltage: The sensor power supply and current signal share the same two-wire shielded cable. The sensor supply voltage should never exceed 26.4 VDC. Always provide complete electrical and physical separation between the sensor supply circuit and the main circuit. **Note:** Remember that the output voltage of the power supply can be lower under nominal load (with a sensor current of 20.5 mA or 22 mA) and/or with the addition of other instruments placed within the circuit. If voltage spikes or surges are expected, adequate isolation protection must also be provided.

Terminal Wiring: The positive (+) and Negative (-) terminals are for connection to a 24 VDC power supply or to a 4-20 mA loop power source. The wire to the terminals can be extended up to 1,000 feet using 22 gauge or larger wire.

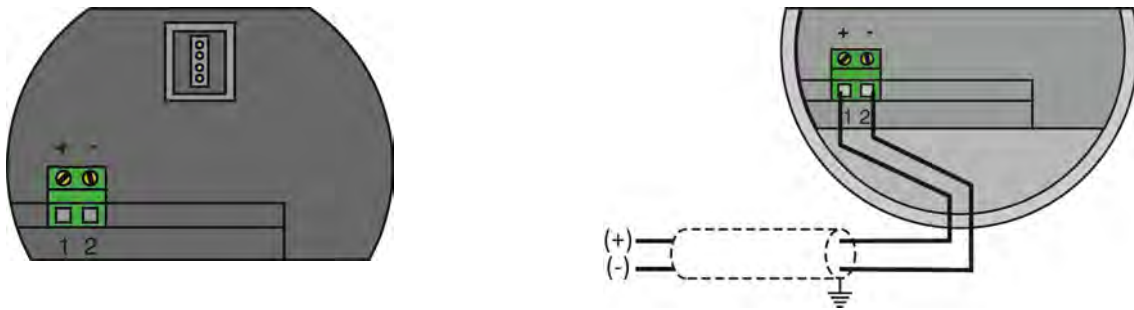

The sensor should be wired with shielded 2-conductor cable (16 to 22 AWG) to protect from electromagnetic interference. If using a liquid tight connector, select a cable with an outer diameter that is designed to ensure an effective seal with the connector [typically between 0.20" to 0.35" (5 to 9 mm)].

ELECTRICAL, USAGE AND SAFETY

1. Wiring should always be done by a licensed electrician in accordance with national, state and local codes.
2. Never use a general purpose (cTUVus) sensor in environments classified as hazardous.
3. Where personal safety or significant property damage can occur due to a spill, the installation must have a redundant fail-safe backup system installed which accounts for sensor and/or power failure.

ANALOG OUTPUT (4-20 MA)

The analog output of the EchoPro® is a loop powered 4-20 mA control circuit. The typical way to use this feature is to connect a positive supply to the (+) input and to sense the current flow out of the (-) output with a sampling resistor as shown in the following control drawing.

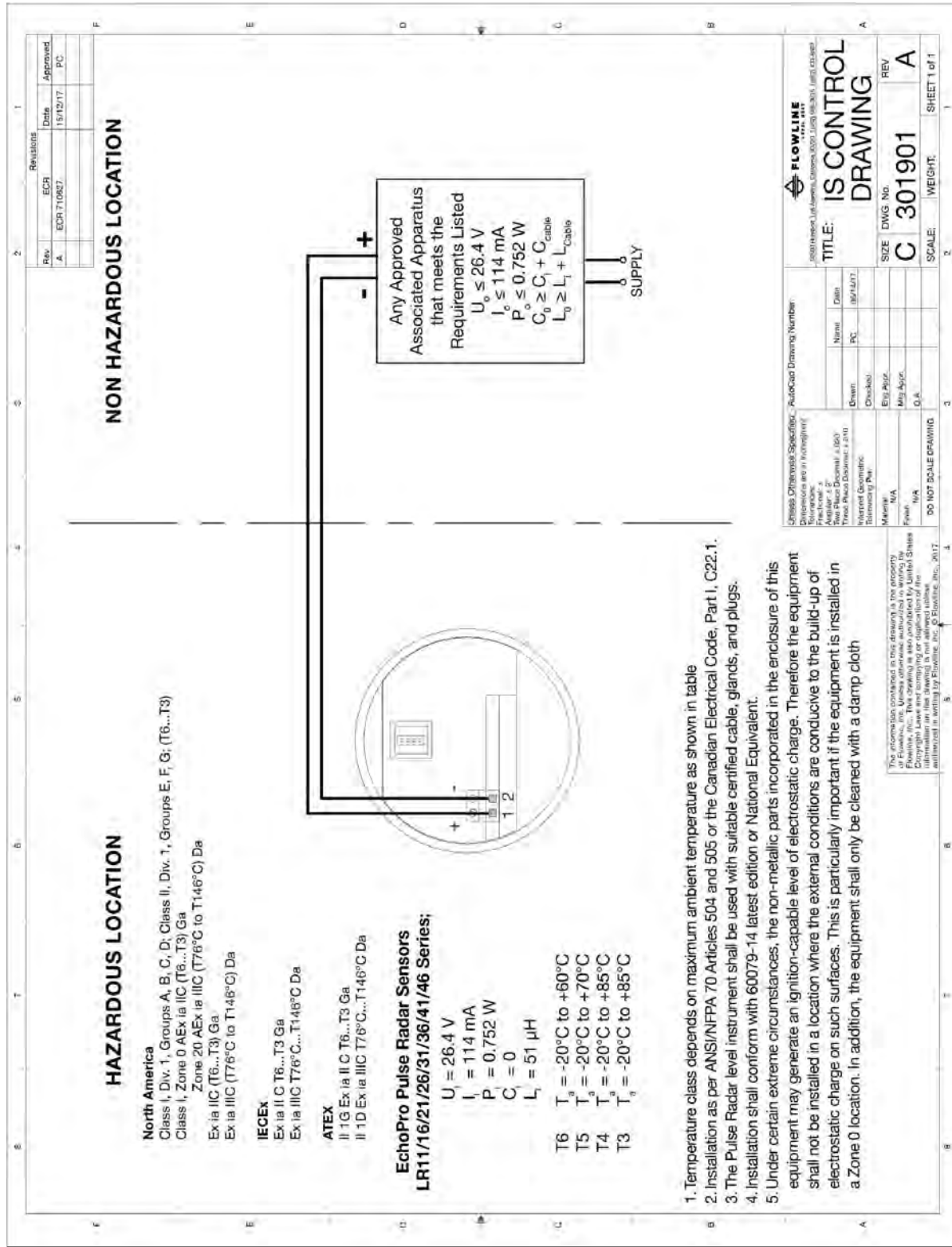

The cabling should be a shielded twisted pair to minimize EMI interference. Typically 20 to 24 gauge wire is used in this application.

WIRING TO DISPLAYS, CONTROLLERS & PLC's

Below are examples of how to wire EchoPro™ to common displays, controllers and PLC's.

**DataView™ LI55 Series
Level Controller**

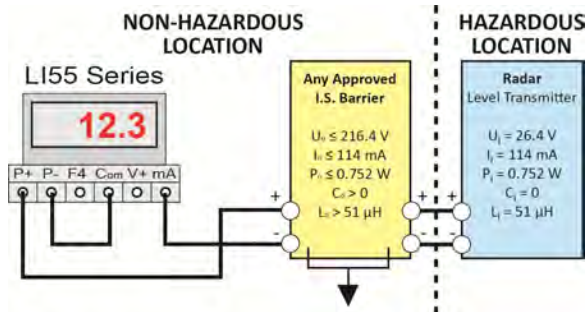

Generic PLC

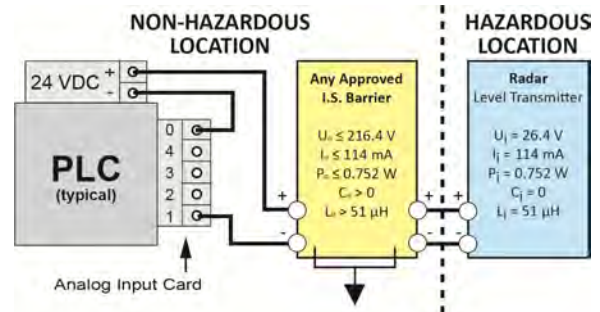

Note: Always refer to the Control Drawing 301901 for further wiring

Generic Loop Powered Display

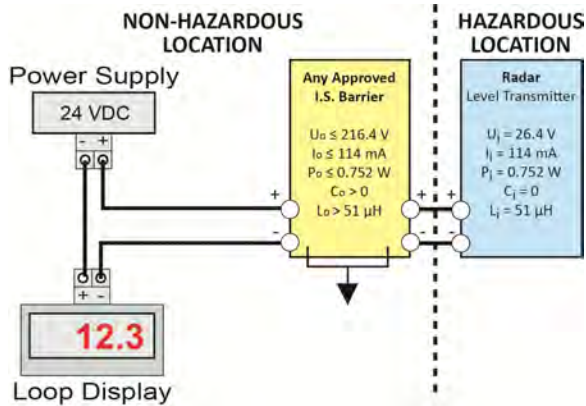

**DataLoop™ LI23 Series Level Indicator
(With Backlight)**

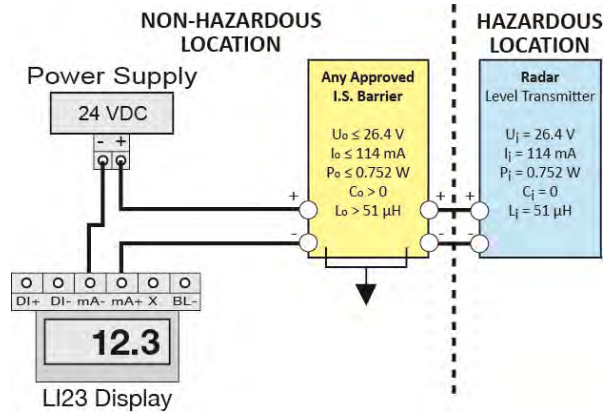

Note: Always refer to the Control Drawing 301901 for further wiring

WARRANTY

Flowline warrants to the original purchaser of its products that such products will be free from defects in material and workmanship under normal use and service in accordance with instructions furnished by Flowline for a period of two years from the date of manufacture of such products. Flowline's obligation under this warranty is solely and exclusively limited to the repair or replacement, at Flowline's option, of the products or components, which Flowline's examination determines to its satisfaction to be defective in material or workmanship within the warranty period. Flowline must be notified pursuant to the instructions below of any claim under this warranty within thirty (30) days of any claimed lack of conformity of the product. Any product repaired under this warranty will be warranted only for the remainder of the original warranty period. Any product provided as a replacement under this warranty will be warranted for the full two years from the date of manufacture.

RETURNS

Products cannot be returned to Flowline without Flowline's prior authorization. To return a product that is thought to be defective, go to www.flowline.com, and submit a customer return (MRA) request form and follow the instructions therein. All warranty and non-warranty product returns to Flowline must be shipped prepaid and insured. Flowline will not be responsible for any products lost or damaged in shipment.

LIMITATIONS

This warranty does not apply to products which: 1) are beyond the warranty period or are products for which the original purchaser does not follow the warranty procedures outlined above; 2) have been subjected to electrical, mechanical or chemical damage due to improper, accidental or negligent use; 3) have been modified or altered; 4) anyone other than service personnel authorized by Flowline have attempted to repair; 5) have been involved in accidents or natural disasters; or 6) are damaged during return shipment to Flowline. Flowline reserves the right to unilaterally waive this warranty and dispose of any product returned to Flowline where: 1) there is evidence of a potentially hazardous material present with the product; or 2) the product has remained unclaimed at Flowline for more than 30 days after Flowline has dutifully requested disposition. This warranty contains the sole express warranty made by Flowline in connection with its products. ALL IMPLIED WARRANTIES, INCLUDING WITHOUT LIMITATION, THE WARRANTIES OF MERCHANTABILITY AND FITNESS FOR A PARTICULAR PURPOSE, ARE EXPRESSLY DISCLAIMED. The remedies of repair or replacement as stated above are the exclusive remedies for the breach of this warranty. IN NO EVENT SHALL FLOWLINE BE LIABLE FOR ANY INCIDENTAL OR CONSEQUENTIAL DAMAGES OF ANY KIND INCLUDING PERSONAL OR REAL PROPERTY OR FOR INJURY TO ANY PERSON. THIS WARRANTY CONSTITUTES THE FINAL, COMPLETE AND EXCLUSIVE STATEMENT OF WARRANTY TERMS AND NO PERSON IS AUTHORIZED TO MAKE ANY OTHER WARRANTIES OR REPRESENTATIONS ON BEHALF OF FLOWLINE. This warranty will be interpreted pursuant to the laws of the State of California. If any portion of this warranty is held to be invalid or unenforceable for any reason, such finding will not invalidate any other provision of this warranty.

For complete product documentation, video training, and technical support, go to www.flowline.com.

For phone support, call 562-598-3015 from 8am to 5pm PST, Mon - Fri.

(Please make sure you have the Part and Serial number available.)