

HDL-MSP08M.4CT
Ceiling Mount 8-in-1 Sensor

buspro

Datasheet

Issued: December 2, 2019
File Edition: A



Figure 1. Ceiling Mount 8-in-1 Sensor

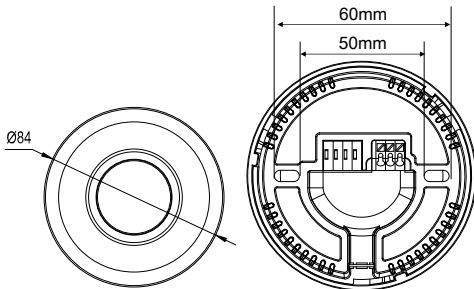

Figure 2. Dimensions-Front View

Figure 3. Dimensions-Back View

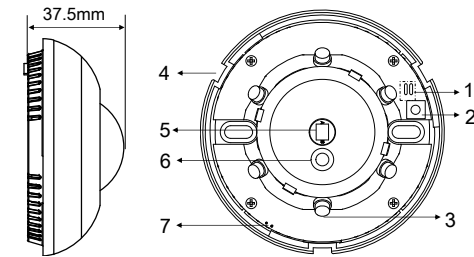

Figure 4. Dimensions-Side View

Figure 5. Components - Interior View

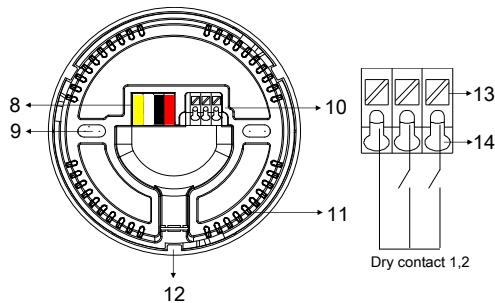

Figure 6. Components - Back View

Figure 7. Dry contact wiring

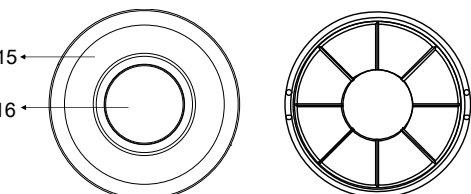

Figure 8. Components - Front View

Figure 9. Accessory - Angle cover

Overview

Ceiling Mount 8-in-1 Sensor (See Figure 1) includes PIR motion sensor, temperature sensor, LUX sensor, dry contact, etc., which can form different logic functions by logic block according to users' requirements. The module supports HDL security mode and commands, and can download IR code from HDL Buspro Setup Tool and emit IR codes in order to control the targets.

Functions

- Built-in PIR sensor, temperature sensor, LUX sensor, IR emitter, dry contact and universal switch.
- Logic inputs include temperature sensor, LUX sensor, PIR sensor, 2 dry contact inputs, 2 universal switches .
- Two logic relations: OR, AND.
- Adjustable PIR sensitivity from 1 to 100
- 12 logic blocks (2 switch numbers for each). 201-240 are assigned for universal switch, which has auto-off function with the delay time of 1-3600s.
- Logic can trigger different targets no matter it is true or false. Up to 10 targets can be triggered by each logic block.
- IR emission function of remote control code, supports 240 infrared emission targets, corresponding to the universal switch number 1-240. When uploading infrared code, multiple infrared codes can be selected to upload at the same time.
- Online update supported via HDL Buspro Setup Tool.
- Constant LUX function.

Important Notes

- Buspro cable - CAT5E or dedicated HDL Buspro cable.
- Buspro connection - Series connection (hand-in-hand recommended).
- Installation position - Ceiling mount
- Check the connection, avoid any mistake
- Installation position: Indoor, keep it away from AC outlet and heat source.
- Dry contact cable requirement: Applicable wire: 0.5~0.75mm² , stripping wire length: 8.5~10mm, shield cable with length less than 20m recommended

Product Information

Dimensions - See Figure 2 - 4

Components - See Figure 5, 6, 8

1. LED indicator and IR indicator
Flashes in blue when the module is in normal working mode
Keeps in red when sensor detects movement
Note: Indicators can be set via HDL Buspro Setup Tool
2. Button for module address setting
Press for 3s, blue indicator turns on. Go to "Address management"-"Address modification" of HDL Buspro Setup Tool to read and modify the address setting.
3. IR emitter
4. Slot
5. PIR sensor
6. LUX sensor
7. Temperature sensor
8. HDL Buspro, from right to left: DC24V, COM, DATA-,DATA+
9. Screw holes
10. Dry contact 1,2
11. Ventilation hole
12. Wiring channel, open it for wiring
13. Pushrod
14. Wiring hole
15. Emitter outlet
16. Fresnel lens

Dry contact wiring - See Figure 7

The wires are put in the wiring hole, and then loosen the pushrod, the wires will be locked.
Put wires in the wiring hole, and loosen the pushrod to lock the wires.

Open the cover to install the sensor, then fix by screws.

Open the cover - See Figure 8: Rotate the cover counterclockwise to take off the cover.

Install the cover - See Figure 8: Put the cover to the correct slot and rotate the cover clockwise.

Accessory - See Figure 9: Angle cover is used to shield PIR sensor signal from certain angle, in order to enlarge or narrow down detection zone according to users' preference.

Detection range - See Figure 10

Installation - See Figure 11 - 14

- Step 1. Rotate and open the sensor.
- Step 2. Fix the sensor base on the wall box with screws.
- Step 3. Put the cover on the sensor.

Safety Precautions

- The installation and commissioning of the device must be carried out by HDL or the organization designated by HDL. For planning and construction of electric installations, the relevant guidelines, regulations and standards of the respective country are to be considered.
- HDL does not take responsibility for all the consequences caused by installation and wire connection that are not in accordance with this document.
- Please do not privately disassemble the device or change components, otherwise it may cause mechanical failure, electric shock, fire or body injury.
- Please resort to our customer service department or designated agencies for maintenance service. The warranty is not applicable for the product fault caused by private disassembly.

Package Contents

HDL-MSP08M.4CT*1 / Buspro connector*1 / Screws*2 / Angle cover*1 / Datasheet*1

Technical Data

Basic Parameters

Working voltage	18~30V DC
Working current	30mA/24V DC
Transmit carrier frequency	38kHz
Detection range	Φ6m (Installation height: 3m)
IR emission distance	4m
Illumination sensing range	0-500lux

External Environment

Working temperature	-5°C~45°C
Working relative humidity	≤90%
Storage temperature	-20°C~60°C
Storage relative humidity	≤93%

Specifications

Dimensions	Φ84mm×37.5mm
Net weight	55.4g
Housing material	ABS
Installation	Ceiling mount (See Figure 11 - 14)
Protection rating (Compliant with EN 60529)	IP20

Name and Content of Hazardous Substances in Products

Components	Hazardous substances					
	Lead (Pb)	Mercury (Hg)	Cadmium (Cd)	Chromium VI (Cr (VI))	Poly-brominated biphenyls (PBB)	Poly-brominated diphenyl ethers (PBDE)
Plastic	o	o	o	o	o	o
Hardware	o	o	o	o	-	-
Screw	o	o	o	x	-	-
Solder	x	o	o	o	-	-
PCB	x	o	o	o	o	o
IC	o	o	o	o	x	x

The symbol "-" indicates that the hazardous substance is not contained.

The symbol "o" indicates that the content of the hazardous substances in all the homogeneous materials of the component is below the limit requirement specified in the Standard IEC62321-2015.

The symbol "x" indicates that the content of the hazardous substance in at least one of the homogeneous materials of the part exceeds the limit requirement specified in the Standard IEC62321-2015.

HDL Buspro Cable Guide

HDL Buspro	HDL Buspro Cable	CAT5/CAT5E
DATA+	Yellow	Blue/Green
DATA-	White	Blue white/Green white
COM	Black	Brown white/Orange white
24V DC	Red	Brown/Orange

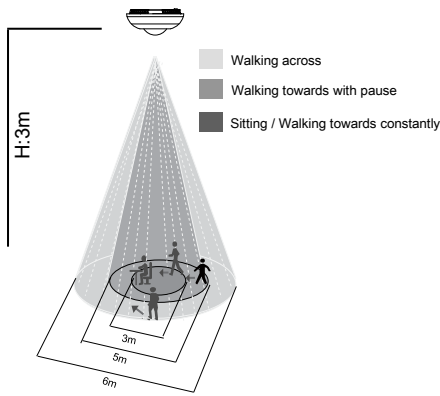

Detection Range (At 25°C)

Mounting height	Sitting / Walking towards constantly	Walking towards with pause	Walking across
3m	3m	5m	6m

Figure 10. Detection range

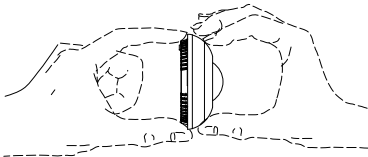

Figure 11

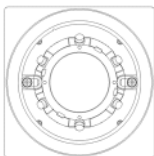

Figure 12

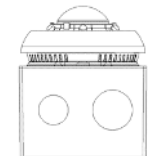

Figure 13



Figure 14

Figure 11 - 14. Installation

Technical support

E-mail: hdtickets@hdlautomation.com

Website: <https://www.hdlautomation.com>

©Copyright by HDL Automation Co., Ltd. All rights reserved.
Specifications subject to change without notice.